

Kildare Market Square

Traffic and Transport Assessment

Kildare County Council

Quality information

Prepared by

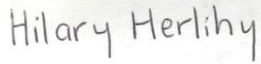

Hilary Herlihy
Consultant

Checked by



Jen Searle
Associate Director

Verified by



David Dewar
Associate Director

Approved by



Jen Searle
Associate Director

Revision History

Revision	Revision date	Details	Authorized	Name	Position
1	07.12.23	Issue to MW	JS	Jen Searle	Associate Director
2	19.12.23	Issue to KCC	JS	Jen Searle	Associate Director

Distribution List

# Hard Copies	PDF Required	Association / Company Name

Prepared for:

Kildare County Council

Prepared by:

Hilary Herlihy

Consultant

E: hilary.herlihy@aecom.com

AECOM Ireland Limited

4th Floor

Adelphi Plaza

Georges Street Upper

Dun Laoghaire

Co. Dublin A96 T927

Ireland

T: +353 1 238 3100

aecom.com

© 2023 AECOM Ireland Limited. All Rights Reserved.

This document has been prepared by AECOM Ireland Limited ("AECOM") for sole use of our client (the "Client") in accordance with generally accepted consultancy principles, the budget for fees and the terms of reference agreed between AECOM and the Client. Any information provided by third parties and referred to herein has not been checked or verified by AECOM, unless otherwise expressly stated in the document. No third party may rely upon this document without the prior and express written agreement of AECOM.

Table of Contents

1.	Introduction.....	6
2.	Planning Policy Review	8
3.	Existing Conditions	11
4.	Proposed Development	17
5.	DMURS Statement of Compliance	23
6.	Trip Reassignment and Distribution.....	25
7.	Junction Impact Analysis	28
8.	Road Safety Audit – Designers Response.....	35
9.	Summary and Conclusions.....	41
	Appendix A Existing Traffic Data.....	42
	Appendix B General Arrangement Drawing.....	43
	Appendix C Visibility Splay	44
	Appendix D AECOM Parking Report.....	45
	Appendix E DMURS Compliance	46
	Appendix F Swept Path Analysis.....	47
	Appendix G Flow Diagrams.....	48
	Appendix H Model Results	49
	Appendix I RSA and Response drawings.....	50

Figures

Figure 1.1.	Site Location	6
Figure 2.1	Greater Dublin Area Cycle Network Plan	10
Figure 3.1	Existing Surrounding Road Network	11
Figure 3.2	R445	12
Figure 3.3	R415 Bride Street	12
Figure 3.4	Market Square Road	13
Figure 3.5	Baseline Flows	14
Figure 3.6	Existing Bus Stops	15
Figure 3.7.	Train Station Proximity	16
Figure 4.1.	Proposed Development Plan	17
Figure 4.2.	Visibility Splay	18
Figure 4.3.	12-hour (7am to 7pm) Traffic survey of OGV1 vehicles Bride Street (R415) / Dublin Street (R445) / Claregate Street junction (R445) junction.	19
Figure 4.4.	12-hour (7am to 7pm) Traffic survey of OGV2 vehicles Bride Street (R415) / Dublin Street (R445) / Claregate Street junction (R445) junction.	19
Figure 4.5.	12-hour (7am to 7pm) Traffic survey of OGV1 vehicles at Bride Street / Market Square East junction.	19
Figure 4.6.	12-hour (7am to 7pm) Traffic survey of OGV2 vehicles at Bride Street / Market Square East junction.	19
Figure 4.7.	Proposed Cycle Parking Locations	20
Figure 4.8.	Market Square Temporary Measures	21
Figure 4.9.	Market Square Car Park Arrangement.....	21
Figure 4.10.	Kildare Town Centre – Car Parking.....	22
Figure 6.1.	Traffic Flows – Bride Street Closure.....	25
Figure 6.2	Traffic Flows – Market Square Closure	26
Figure 7.1	Bride Street / Dublin Street Junction Layout	29
Figure 7.2	Bride Street / Market Square Junction Layout.....	31
Figure 7.3	R445 Dublin Street / Market Square Junction Layout	32
Figure 8.1	Temporary signage required.	35

Figure 8.2 Temporary Signage – Bride Street Closure	36
Figure 8.3 Temporary Signage – Market Square Closure	36
Figure 8.4 Proposed Swept Path with Large Refuse Vehicle	38
Figure 8.5 Proposed Swept Path with Large Refuse Vehicle	38
Figure 8.6 Extended tactile paving at crossing and Warning tactile paving along edge of carriageway.	39
Figure 8.7 Example tactile paving for carriageway edge Dimensions 400 x 400	39

Tables

Table 3.1. Bus Servicing and Routing	15
Table 6.1 National Traffic Growth Forecasts: Annual Growth Factors	26
Table 6.2 Percentage Impacts AM.....	27
Table 7.1 PCU Values	28
Table 7.2 Bride Street / R445 Dublin Street Observed Queue Data (PCUs).....	29
Table 7.3 Bride Street / R445 Dublin Street Base Scenario	30
Table 7.4 Future scenarios of Bride Street / R445 Dublin Street junction assessment.....	30
Table 7.5 Bride Street / Market Square Observed Queue Data (PCUs).....	31
Table 7.6 Bride Street / Market Square	31
Table 7.7 Future scenarios of Bride Street / Market Square junction assessment	32
Table 7.8 R445 Dublin Street / Market Square Observed Queue Data (PCU's).....	33
Table 7.9 R445 Dublin Street / Market Square Base Results	33
Table 7.10 R445 Dublin Street / Market Square Market Junction Assessment	33

1. Introduction

1.1 Introduction

AECOM has been commissioned by Kildare County Council (KCC) to provide a Traffic and Transport Assessment (TTA) in support of the planning application for a part 8 public realm redevelopment of Kildare Market Square in Kildare town, Co. Kildare. The site location is shown in Figure 1.1.

Figure 1.1. Site Location



Source: Bing Maps 2023

The report has been prepared in compliance with the following guidance and policy documents:

- Kildare County Development Plan (2023 – 2029);
- Kildare County Council Town Transport Strategy
- Project Ireland 2040: The National Planning Framework and the National Development Plan (2018).
- National Sustainable Mobility Policy (2022).
- TII (Transport Infrastructure Ireland) Transport Assessment Guidelines (May 2014);
- The NTA Traffic Management Guidelines (2012); and
- PE-PDV-02045 TTA Guidelines (May 2014), Transport Infrastructure Ireland.
- Design Manual for Urban Roads and Streets, DMURS, May 2019 (Dept of Transport, Tourism and Sport/ Dept of Environment, Community & Local Govt);
- Geometric Design of Junctions (priority junctions, direct accesses, roundabouts, grade separated, and compact grade separated junctions), DN-GEO-03060, (TII, June 2017); and
- Standards for Cycle Parking and associated Cycling Facilities for New Developments (January 2018);

1.2 Proposed Development

The proposals include a regeneration of the existing Market Square in to an area of Public Realm space for the community. It is proposed to improve the existing road and pedestrian network of the square by increasing pedestrian crossing widths, removing parking bays and extending bus stop laybys. It is proposed to install a combination of temporary and retractable bollards on Bride Street and Market Square to allow one or both roads to be closed during market days or special events.

1.3 Study Methodology

The purpose of this TIA is to provide a comprehensive and systematic review of the transport implications relating to the proposed development. The assessment has been undertaken in line with the guidelines set out in Transport Infrastructure Ireland's (TII's) 'Traffic and Transport Assessment Guidelines'.

The remainder of this report is divided into the following sections:

- **Section 2** – Identifies and discusses current policy context;
- **Section 3** – Examines current highway conditions;
- **Section 4** – Provides details of the proposed development;
- **Section 5** – Provides a DMURS compliance review;
- **Section 6** – Analyses the proposed trip generation and Distribution;
- **Section 7** – Provides Junction Impact Results;
- **Section 8** – Examines the Stage 1 Road Safety Audit undertaken on the scheme;
- **Section 9** – Provides a concise summary and conclusion.

2. Planning Policy Review

2.1 Introduction

This section reviews the relevant policy and guidance for the regeneration of the Market Square in Kildare. Relevant aspects of the following policies, plans and programmes are discussed:

- Project Ireland 2040 (2018): The National Planning Framework and the National Development Plan;
- National Sustainable Mobility Policy (2022);
- Irish Statute Book (2001);
- Kildare County Council Development Plan 2023-2029;
- Kildare Town Local Area Plan 2023 – 202; and
- Kildare Town Transport Strategy.

2.2 National Policy

Project Ireland 2040 (2018): The National Planning Framework and the National Development Plan.

The National Planning Framework (NPF) published in February 2018 is a national document intended to guide at a high-level strategic planning and development for Ireland over the next 20+ years, so that as the population grows, that growth is sustainable (in economic, social, and environmental terms). The NPF details ten 'National Strategic Outcomes' and the National Development Plan 2018-2027 outlines how public capital investment over the next ten years aims to secure the realisation of each of these under corresponding 'Strategic Investment Priorities'.

The NPF with the National Development Plan sets the context for each of Ireland's three regional assemblies to develop their Regional Spatial and Economic Strategies taking account of and co-ordinating local County and City Development Plans in a manner that will ensure national, regional, and local plans align.

The goal of Sustainable Mobility is highlighted within the Shared Goals – Our National Strategic Outcomes section. In line with Ireland's Climate Change mitigation plan, the plan states that the need to progressively electrify mobility systems moving away from polluting and carbon intensive propulsion systems to new technologies such as electric vehicles and introduction of electric and hybrid traction systems for public transport fleets. The goal is that by 2040 cities and towns will enjoy a cleaner, quieter environment free of combustion engine driven transport systems.

National Sustainable Mobility Policy (2022)

The National Sustainable Mobility Policy was published in April 2022 and sets out the strategic framework to 2030 for active travel and public transport to support Ireland's overall requirement to achieve a 51% reduction in carbon emissions by 2030. The targets of the policy are to increase daily active travel and public transport journeys by 500,000, as well as a 10% reduction in kilometres driven by fossil fuelled cars by 2030. This target is in line with metrics for transport set out in the Climate Action Plan 2021.

The vision of the policy is "to connect people and places with sustainable mobility that is safe, green, accessible and efficient". This vision is guided by the three key principles of: safe and green mobility, people focused mobility, and better integrated mobility. The main goals that are relevant to this MMP are the expanding availability of sustainable mobility in metropolitan, regional, and rural areas, and to encourage people to choose sustainable mobility over the private car.

The expanding of availability of sustainable mobility in metropolitan, regional, and rural areas will be improved through walking, cycling, bus, and rail infrastructure, improved transport interchange and expanded public transport services. Reducing reliance on the private car will be completed through the reallocation of road space from cars to sustainable travel methods, delivering safer walking and cycling options, and reducing parking provision.

Sustainable mobility policy is intricately linked to other policy areas including education, environment, health, investment, planning and social inclusion, and a collaborative approach has been taken in the development of the Policy. The proposed development helps to achieve Goal 1 of the policy, Improve Mobility Safety.

Irish Statute Book (S.I. No. 600/2001 Planning and Development Regulations)

Part 8 allows for the application of planning permission for projects by local authorities. Detailed requirements in respect of Specified Development by, on Behalf of, or in Partnership with Local Authorities is listed within the Irish statute books. S.I. No. 600/2001.

2.3 Local Policy

Kildare County Development Plan 2023-2029

The Kildare County Development Plan was published in 2023 and aims to provide a clear statement of the shared priorities of Kildare County. Chapter 5: Sustainable Mobility & Transport aims to promote and facilitate ease of movement within and through County Kildare, by integrating sustainable land use planning and a high-quality integrated transport system; and to support and prioritise investment in more sustainable modes of travel, the transition to a lower carbon transport system, and the development of a safer, efficient, inclusive, and connected transport system.

The council's objective TM07 aims to 'Introduce measures to reduce traffic congestion in town centres such as pedestrianisation, pedestrian priority and/or improved pedestrian/cycling facilities, in particular increasing the number of safe crossings.' This scheme complies with this policy as it proposes more crossings around Market Square and the widening of existing crossings to make the area safer and more accessible for pedestrians and cyclists.

TM08 aims to 'investigate the feasibility of locations for car-free residential, town centre and other developments, in appropriate locations near high quality, frequent public transport services, as part of the preparation of the suite of Local Area Plans. This scheme complies with this policy as it proposes removal bollards to create no vehicle zone which can be implemented at busier times such as market days.

Kildare Town Local Area Plan 2023 – 2029

The Plan sets out an overall strategy for the proper planning and sustainable development of the town of Kildare in the context of the National Planning Framework (2018), the Regional Spatial and Economic Strategy for the Eastern and Midland Region 2019-2031 and the Kildare County Development Plan 2023-2029.

The Vision for Kildare Town over the lifetime of this Plan seeks:

“To promote the social, economic and physical development of Kildare Town as a self-sustaining growth town in a compact, permeable and sequential manner; to address deficiencies in social infrastructure so communities may thrive; to ensure the town centre develops as an inclusive, vibrant, attractive and connected place; to harness the town’s existing strengths of equine, ecclesiastical and retail assets; and to create a high-quality, low carbon, universally accessible environment for residents and visitors alike.”

The key principles on which the Vision are as follows:

- Creating compact and connected communities;
- Achieving a high quality low carbon environment;
- Delivering catch up infrastructure;
- Enhancing Kildare Town as a Tourist Destination;
- Ensuring a vibrant town centre; and
- Supporting intergenerational community living.

Town centre Objectives for the council including TCO 1.1 to TCO 1.6 prioritises town centres to keep their identity, character and overall use for the residents. A key priority of this Plan is the urban renewal of the Kildare Town Centre to create a more attractive environment for both locals and visitors. Public realm is defined as the publicly owned places and spaces that belong to and are accessible by everyone. An enhanced public realm in Kildare Town Centre will promote activities, business and vitality while also strengthening the heritage, identity and character, through a well-designed series of streets and spaces that feel inviting, safe and a place people want to be. The proposed public realm scheme presented in this TTA provides high-quality public spaces in town centres are proven to enhance the setting of historic buildings and spaces, improve the image of a centre and to make the town a more attractive and vibrant place.

Kildare Town Transport Strategy (2021)

The Kildare Town Transport Strategy was published in 2021 and aims to focus on sustainability by encouraging compact growth and a model shift away from car transport. The proposed scheme aims will align to this aim by making the market square more accessible to pedestrians and cyclists by having the option to close Market Square to vehicles on market days.

Another aim of the strategy is to prioritise walking and cycling links. This proposed public realm scheme proposes additional crossing points around the square as well as widening existing crossings points to allow for greater capacity of pedestrians and cyclists.

2.4 Transportation Infrastructure - Cycle

The Greater Dublin Area Cycle Network Plan sets out the National Transport Authority’s Plan for a cycle network throughout the greater Dublin Area. The Plan aims to ensure that cycling as a transport mode is supported and enhanced in order to achieve strategic objectives. The Kildare Routes identified within the plan are listed below and illustrated in Figure 2.2:

- KT1 Melitta Road -R415 Station Road – The Square;
- KT2 R445 Dublin Street/ Monesterevin Road, Kildare; and
- KT3 Grey Abbey Road.

Figure 2.1 Greater Dublin Area Cycle Network Plan

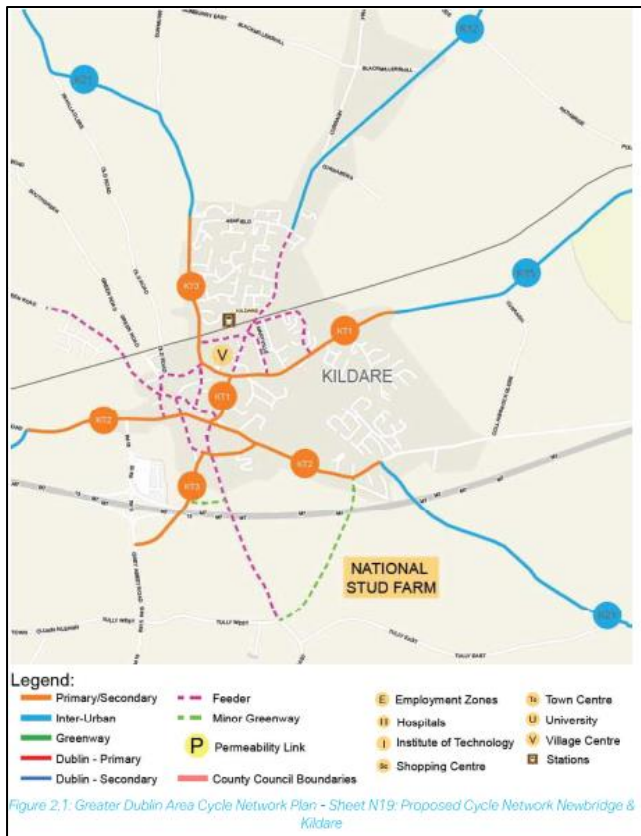

Source: Kildare Town Transport Strategy

2.5 Summary

The proposed scheme of regenerating the town centre into an open pedestrian friendly public realm is in line with current local and national policy.

3. Existing Conditions

3.1 Introduction

This chapter includes a review of the existing baseline conditions of the Market Square including public transport provision, walking and cycling facilities and the current operation of the existing public network. AECOM undertook a number of site audits to identify the existing conditions in the vicinity of the site. The findings from AECOM's analysis are presented within this chapter.

3.2 Existing Local Road Network

The redevelopment of the site is located in the centre of Kildare Town called the 'Market Square'. The public realm site is currently functioning as a two way traffic flow system with uncontrolled crossing points. It is located in Central Kildare Town and is shown in Figure 3.1.

Figure 3.1 Existing Surrounding Road Network

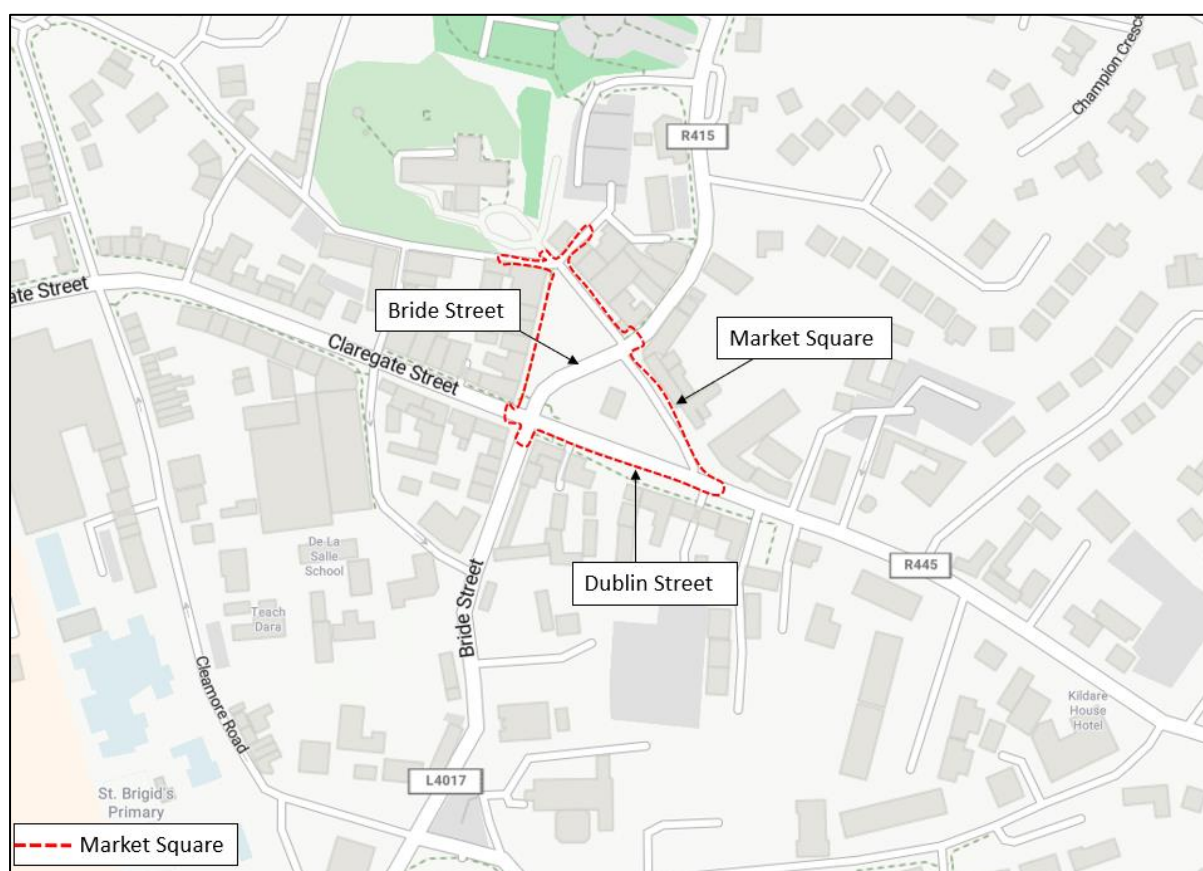

Source: Bingmaps.com

The local roads which make up the proposals are as follows:

- R445 Dublin Street
- R415 Bride Street
- Market Square

R445 Dublin Street

The R445 is a two-way single lane carriageway which is generally 8m wide in each direction with a 2.5 m wide parking lane on the southern side as shown in Figure 3.2. The speed limit of this road is 50KM/hr with pedestrian footways on both sides. Parking bays are provided on the southern side and double yellow lines on the northern side. There are no dedicated cycle way and public street lighting is present.

Figure 3.2 R445



R415 Bride Street

The R415 Bride Street is a two way regional road which is approximately 6.8m wide with double yellow lines on the southern side and permanent bollards on the northern side. There is public street lighting on the northern side of the R415 and the speed limit is identified as 50Km. There are dedicated pedestrian footways on both sides. Figure 3.3 shows the current conditions.

Figure 3.3 R415 Bride Street



The Market Square

The Market Square Road is a two way dual lane carriageway which is approximately 6m wide with parking bays on either side measuring at 3m wide each. On the southern side of the street the parking is permitted to two hours max, while on the north side the dedicated parking space is divided between loading and pay and display parking. On Thursdays there is a market on the northern side of the road from 6am to 2pm and parking is asked to be refrained from in this area.

There is public street lighting on the northern side of the square and the speed limit is directed as 30km/hr. There are dedicated pedestrian footways on both sides and current conditions are shown in Figure 3.4.

Figure 3.4 Market Square Road



3.3 Existing Baseline Traffic

In order to establish the existing local road networks traffic characteristics and subsequently enable the identification of the potential impact of the proposed development, traffic surveys were conducted by Irish Traffic Surveys (ITS) on Friday the 21st of January 2022. TII guidance states Traffic surveys should be undertaken during Neutral Periods which avoids national and local holiday and school holiday periods. Aecom can confirm there were no national, local or school holidays during the survey period and it was agreed with Kildare Council the use of these surveys was acceptable for this TTA. These traffic surveys consisted of a 12-hour (07:00 – 19:00) Junction Turning Count (JTC) at the following junctions:

- R415 Bride Street/R445 Dublin Street/R445 Claregate Street;
- R415 Bride Street/Market Square;
- R445 Dublin Street/Market Square;
- R415 Bride Street/Car Park Station Road;
- Kildare Shopping Centre Car Park/Unnamed Road; and
- R415 Bride Street/Bride Street Car Park South Entrance.

The traffic surveys established that the local morning and evening peak hour occurs between 08:15 – 09:15 and 16:45 – 17:45, respectively. Figure 3.5 shows the 2022 baseline traffic surveys for the morning and evening peak hours. The recorded 2022 peak hour traffic flows are presented within Appendix A.

Figure 3.5 Baseline Flows

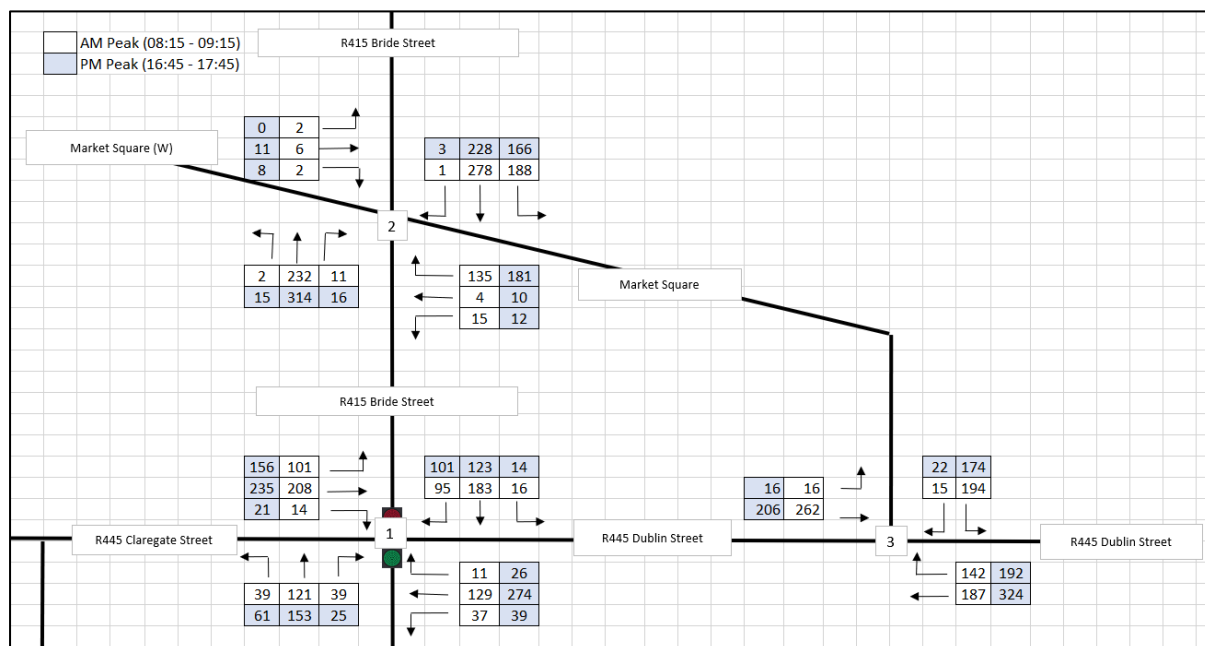

The 2022 surveys showed the following:

- 876 total vehicles in the AM peak using Market Square / Bride Street junction and 974 in the PM peak;
- 993 total vehicles in the AM peak using Dublin Street / Bride Street junction and 1,228 in the PM peak; and
- 816 total vehicles in the AM peak using Dublin Street / Market Square junction and 934 in the PM peak.

3.4 Road Collision Statistics

Transport Infrastructure Ireland's (TII's) 'Traffic and Transport Assessment Guidelines' states an analysis of road collisions should be provided within the vicinity of the proposed development site. Usually, AECOM would review of the Road Safety Authority (RSA) traffic collision database for the road network in the vicinity of the proposed site to identify any collision trends. This review is aimed to assist to identify any potential safety concerns in relation to the existing road network. However, the RSA website has been offline due to GDPR issues, and it is unclear when the site will be updated and back up and running for use.

3.5 Existing Active Transportation Infrastructure

Sustainable transport is considered a vital part of the community with bus, rail and car share providing essential services for locals to get around. The following sub-sections demonstrate the availability and locality of various sustainable modes of transport in relation to the subject site.

3.5.1 Active Travel – Walking and Cycling

A summary of walking distance from the centre of the square to key facilities is as follows:

- 33m to Bank of Ireland The Square Kildare
- 109m to St. Brigid's Cathedral and Round Tower
- 125m to Kildare Post Office
- 122m to Kildare Town Library
- 230m to Kildare Garda station;
- 550m to Carmelite Friary Church Kildare
- 670m Kildare Train Station
- 450m to Kildare Town GAA Club

- 550m to Kildare Village Retail Outlet

In the vicinity of the site, there are no dedicated or shared cycle lanes marked on the road network surrounding the subject site.

3.5.2 Sustainable Transport – Bus

As illustrated in Figure 3.6 the market square is situated with the benefit from bus transport connections allowing site users to travel to and from by this sustainable mode. There are four bus stops located within a 400m walking catchment of the site two of which are located on Dublin Street. These bus stops are operated by various bus providers.

Figure 3.6 Existing Bus Stops

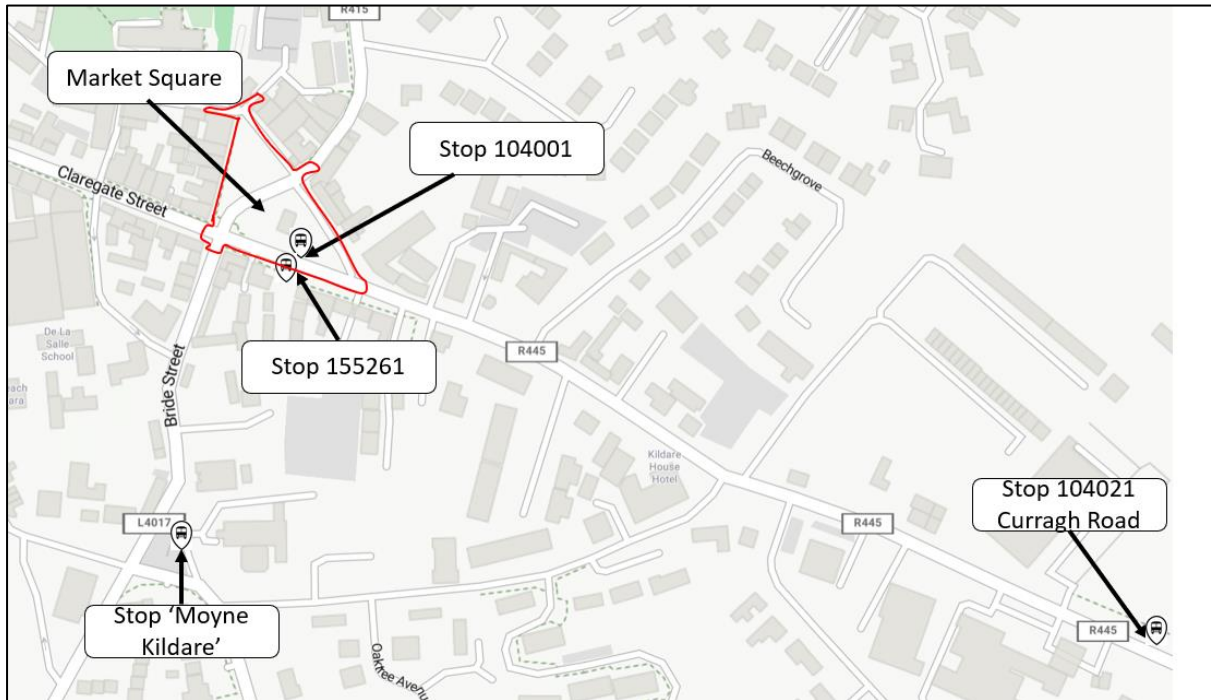

Source Journey Planner.ie

Services available at stops surrounding the site are shown in Table 3.1.

Table 3.1. Bus Servicing and Routing

Route No.	Operator	Route	Services AM and PM Peak Hours		
			Monday to Friday	Saturday	Sunday
726	Dublin Coach	Portlaoise –Kildare- Newbridge - Naas Dublin Airport	One service every hour	One service every hour	One service every hour
126	GoAhead Commuter	DCU – Heuston- Naas- Newbridge – Curragh – Kildare - Rathangan	One service every 30 mins	One service every 30 mins	One service every 30 mins
126A	GoAhead Ireland	Docklands – Red Cow -Naas - Kildare – Rathangan	One service a day	One service a day	One service a day
UM14	JJ Kavenagh and Sons	Portlaoise Centre -Port Arlington - Newbridge -Kildare - Maynooth	3 Services per day	No Service	No Service

3.5.3 Sustainable Transport –Rail

The closest railway station to the site is the Kildare Train Station located 670m (5min walk) northwest of the market square. Kildare Train Station is located five stops away from Dublin Heuston, which forms part of the South Western Commuter service which provides rail services west to Galway, Limerick and Cork. Figure 3.7 illustrates the site location in relation to Kildare Train Station.

Figure 3.7. Train Station Proximity



Source: Bing Maps

4. Proposed Development

4.1 Introduction

This Section sets out the development proposals from Kildare County Council for an upgrade to the existing Kildare County Market Square that is located in Kildare Town, Co. Kildare.

4.2 Proposed Development

Kildare County Council has had aspirations for the Market Square to regenerate the area create a public realm space for the community. It is proposed to improve the existing road and pedestrian network of the square by increasing pedestrian crossing widths, removing parking bays and extending bus stop laybys. It is proposed to install a combination of temporary and retractable bollards on Bride Street and Market Square to allow one or both roads to be closed during market days or special events. The proposed plan is shown in Figure 4.1. The general arrangement drawing is presented in Appendix B.

Figure 4.1. Proposed Development Plan



Source: Metropolitan Workshop drawing 2018_MET_ZZ_XX_DR_A_100004_P8

There are new pedestrian crossings proposed at the Northwest, Northeast and Southeast arms of the Market Square/Bride Street junction, at the Northwest arm of the Bride Street/Dublin Street junction, at the Southeast end of Market Street, and on Dublin Street at the Southeast end of the site. There is also proposed footway widening at the existing three arms of the Bride Street/Dublin Street junction. These crossings comprise of tactile paving and flushed kerbs to facilitate pedestrian movements crossing the carriageways of Market Square, Bride Street and Dublin Street. A

During the Covid-19 pandemic, the car park in the north west of Market Square was pedestrianised and turned into a space where people can socialise, eat outside or attend a regular weekend market. The closure of the Bride Street section of Market Square would allow for the pedestrianised space to be extended to Kildare Town Tourism Office, which would create a plaza in the centre of the town which could be used for a larger market, outdoor dining

and cultural events. This plaza would enhance the public realm of the town centre and strengthen the appeal of visiting Kildare town for retail, social or tourism activities. A new accessible parking space has been proposed opposite the junction of Dublin Street and Market Square. Parking spaces have also been provided to the north side of the Bride Street /Market Square junction.

4.3 Visibility Splays

As part of the scheme proposals, the mouth of the junction of Market Square and Dublin Street has been narrowed to enable a safer pedestrian crossing point.

This junction and the whole scheme has been designed to DMURS complaint standards which is presented in Section 5 of this report. Visibility splays are provided to illustrate sight lines toward and down intersecting streets to ensure that drivers have sufficient reaction time to stop should a vehicle enter their path. The X distance is 2.4m and the Y distance is to the edge of carriageway. The Y distance is 45m in length as per the DMRUS standards for a road of 50kmp. This is felt to be adequate based on the location of the junction and site observations confirmed overall good visibility. The visibility splay is provide in Figure 4.2 and Appendix C.

Figure 4.2. Visibility Splay



Source: AECOM Drawing 60594179-ACM-00-XX-SK-CE-10-00110

4.4 Servicing

A large number of HGVs currently flow through the town centre, any proposals to close roads within the Market Square would have an impact.

Traffic surveys were undertaken on Thursday 18th October 2018 at the Bride Street (R415) / Dublin Street (R445) / Claregate Street junction (R445). This data was collected by AECOM for KCC on a previous project and it was agreed would be included within the TTA for this Part 8 application. Given the data was collected before COVID it has been deemed acceptable to use for information purposes.

The traffic surveys highlight that approximately 2.5% of the 11,287 vehicles recorded at this junction over a 12-hour period were either OGV1 or OGV2 vehicles. In total 165 OGV1s were recorded on the junction over the 12-hour period, with 89 OGV1 vehicles accessing Bride Street, as shown in Figure 4.3. In total 113 OGV2s were recorded on the junction over the 12-hour period, with 85 OGV2 vehicles accessing Bride Street, as shown in Figure 4.4.

Figure 4.3. 12-hour (7am to 7pm) Traffic survey of OGV1 vehicles Bride Street (R415) / Dublin Street (R445) / Claregate Street junction (R445) junction.

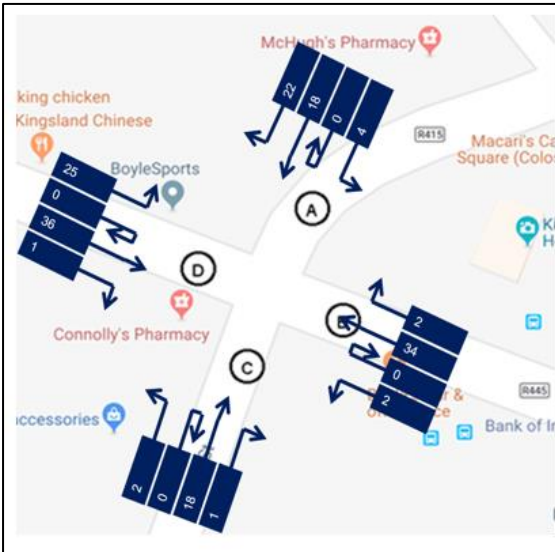
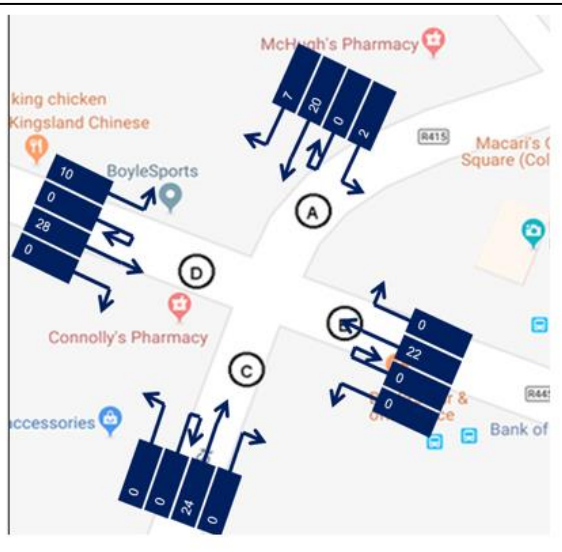

Figure 4.4. 12-hour (7am to 7pm) Traffic survey of OGV2 vehicles Bride Street (R415) / Dublin Street (R445) / Claregate Street junction (R445) junction.



At the Bride Street / Market Square East junction the main HGV movements are on Bride Street. However, there is still a small number of HGVs using Market Square East. In total 144 OGV1s were recorded on the junction over the 12-hour period, with 50 OGV1 vehicles accessing Market Square East, as shown in Figure 4.5. In total 71 OGV2s were recorded on the junction over the 12-hour period, with 10 OGV2 vehicles accessing Market Square East, as shown in Figure 4.6.

Figure 4.5. 12-hour (7am to 7pm) Traffic survey of OGV1 vehicles at Bride Street / Market Square East junction.

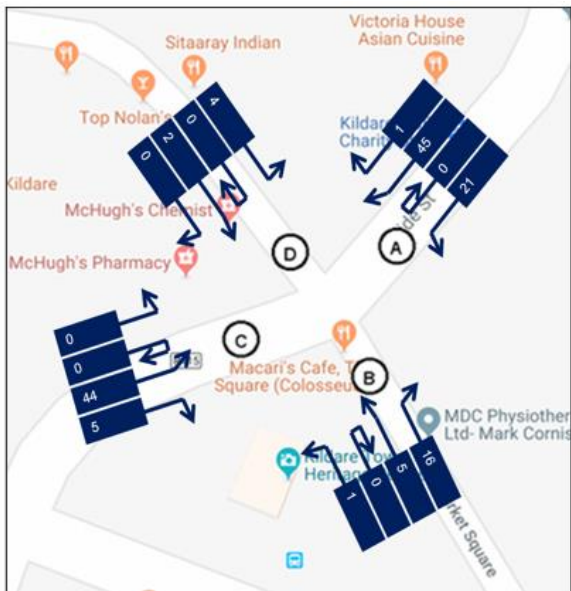
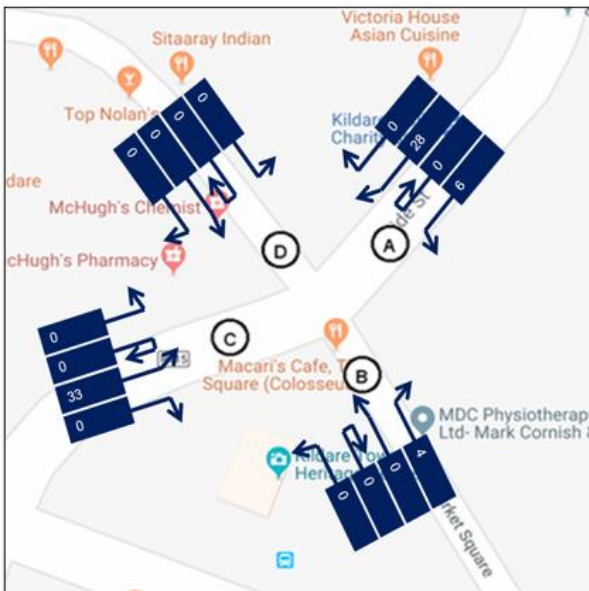

Figure 4.6. 12-hour (7am to 7pm) Traffic survey of OGV2 vehicles at Bride Street / Market Square East junction.



4.5 Cycle Parking

The proposals include 18 new Bike stands to be provided within the market square. 12 will be provided on Dublin Street to east of the Market Square Junction and a further 6 will be provided on Market Square West outside existing shops and residential units. Cycle parking locations are shown in Figure 4.7.

Figure 4.7. Proposed Cycle Parking Locations



Source: Metropolitan Workshop drawing 2018_MET_ZZ_XX_DR_A_100004_P8

4.6 Parking Provision

Creating a public realm at the Market Square has resulted in the removal of parking bays on Dublin Street and Market Square. It should be noted that the number of car parking spaces on Market Square has been reduced since 2020, with a temporary pedestrian public realm scheme in place. Previously there were approximately 38 parking spaces west of Bride Street on Market Square. Currently the layout of the Market Square accommodates an enlarged public space to better accommodate outdoor activity in Kildare which has been illustrated in Figure 4.8. As part of this Part 8, it is proposed to regularise this current arrangement with a further reduction of 17 spaces on Dublin Street and Market Square East. 6 No. spaces (incl 2 accessible) will be reintroduced to the Market Square as part of the scheme. The previous arrangement has been illustrated in Figure 4.9.

Figure 4.8. Market Square Temporary Measures



Figure 4.9. Market Square Car Park Arrangement

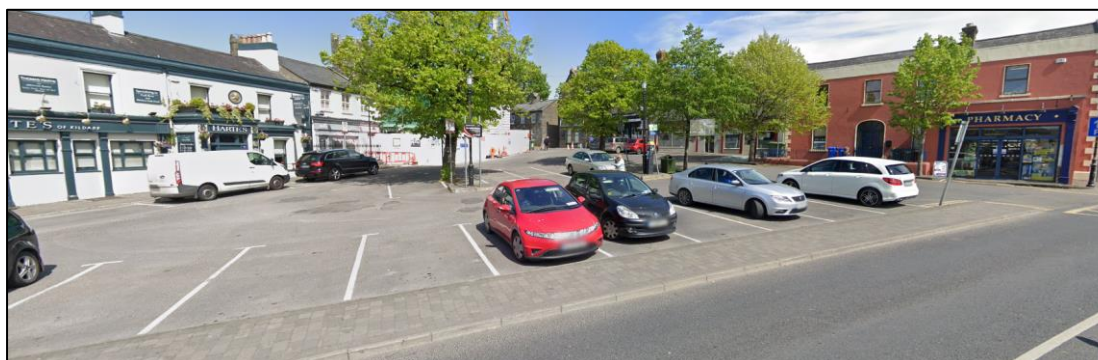

(Source: Google Streetview, May 2019)

In 2022, AECOM were commissioned by Kildare County Council to undertake a Parking assessment of the town to understand the existing parking arrangements. Parking surveys were undertaken at all the main on-street and off-street parking locations in Kildare Town Centre on Friday the 21st, Saturday the 22nd and Sunday the 23rd of January 2022, over a twelve hour period from 07:00 – 19:00 to capture all peak parking periods.

The on-street and off-street car parking considered as part of this parking assessment are as follows with the locations of the car parks shown in Figure 4.10. In total there are 353 car parking spaces across the 13 car parking locations.

1. Bride Street Car Park (80 spaces)
2. Church Car Park (16 spaces)
3. Nugent Street Car Park (47 spaces)
4. Claregate Street (27 spaces)
5. Market Square (12 spaces)
6. Main Street (23 spaces)

7. Cleamore Road (32 spaces)
8. Fire Castle Lane (9 spaces)
9. Silken Thomas Car Park (56 spaces)
10. CMWS Hall Kildare Parking (19 spaces)
11. Station Road Parking (11 spaces)
12. Bridge Street (17 spaces)
13. Bangup Lane (4 spaces)

Figure 4.10. Kildare Town Centre – Car Parking

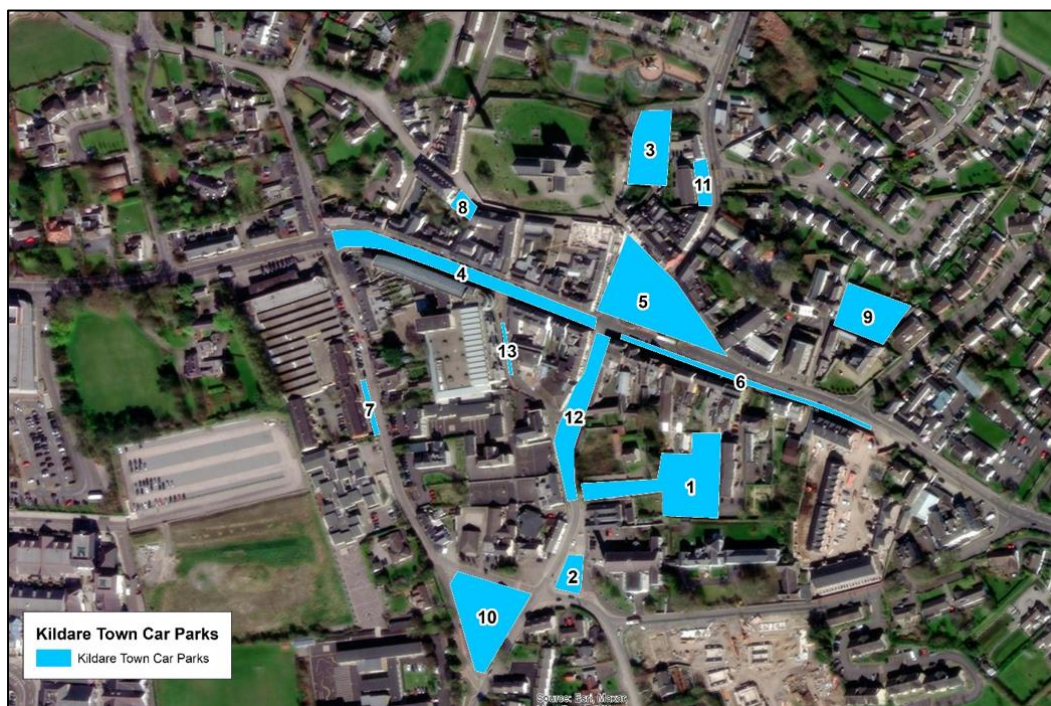

(Source: Google Maps)

From the review of the parking surveys, the peak parking demand periods were observed as follows:

- Friday 21st January - 14:30 – 15:30 with 303 parking spaces occupied (86% Max Occupancy);
- Saturday 22nd January - 14:00 – 14:30 with 260 parking spaces occupied (74% Max Occupancy); and,
- Sunday 23rd January - 11:00 – 11:30 with 246 parking spaces occupied (70% Max Occupancy).

The technical note presenting the results of the parking study are provided in Appendix D.

The local car parks which surround the Market square can cater for the spaces which have been removed as part of these proposals.

5. DMURS Statement of Compliance

5.1 General

This chapter comprises of a Statement of Compliance, prepared for the Part X (section 175) of the Planning and Development Act 2000-2021. It is recommended to include the following sections with appropriate commentary relevant to the proposed development. A DMURS Compliance drawing has been produced and can be found in Appendix E.

5.2 Compliance with DMURS

AECOM has set out in the following sections how the proposed development is compliant with the DMURS guidelines.

It is AECOM's opinion that the proposed development is consistent with both the principles and guidance outlined within DMURS. The scheme proposals are the outcome of an integrated approach that seeks to implement a sustainable community connected by well-designed streets which deliver safe, convenient and attractive networks in addition to promoting a real and viable alternative to car-based journeys.

The adopted design approach successfully achieves the appropriate balance between the functional requirements of different network users whilst enhancing the sense of place. The implementation of self-regulating streets actively manages movement by offering real modal and route choices in a low speed, high quality residential environment.

The main objective of this report is to examine the design principles of the proposed development with reference to the two core principles presented within DMURS, as outlined below:

1. Street Networks: To support the creation of integrated street networks which promote either level of permeability and legibility for all users and in particular more sustainable forms of transport.
2. Street Design: The promotion of multi-functional, place-based streets that balance the needs of all users within a self-regulating environment.

5.3 Street Networks

Specific attributes of the street network which contribute to achieving the DMURS objective include:

- Well designed and frequently provided pedestrian crossing facilities are provided along key desire lines throughout the site. All courtesy crossings are provided with dropped kerbs thereby allowing pedestrians to informally assert a degree of priority.
- A variety of materials and finishes will be specified in the shared areas to indicate that the carriageway is an extension of the pedestrian domain.

5.4 Street Design

The internal layout design has been informed by Chapter 4 of the DMURS guidelines and is in accordance with these guidelines. The following measures are examples of where compliance with the recommended street design guidelines has been demonstrated:

5.4.1 Streetscape

- Pedestrian crossings are proposed which comprise of tactile paving and dropped kerbs to facilitate pedestrian movements throughout the site.
- DMURS also gives guidance on the types of materials and finishes to be used in order to provide a sense of calm for traffic and improve legibility for vulnerable road users. All carriageways, footpaths and tactile paving are proposed to be of visually contrasting colour.

5.4.2 Pedestrian and Cyclist Environment

- There are new pedestrian crossings proposed at the Northwest, Northeast and Southeast arms of the Market Square/Bride Street junction, at the Northwest arm of the Bride Street/Dublin Street junction, at the Southeast end of Market Street, and on Dublin Street at the Southeast end of the site. There is also

proposed footway widening at the existing three arms of the Bride Street/Dublin Street junction. These crossings comprise of tactile paving and flushed kerbs to facilitate pedestrian movements crossing the carriageways of Market Square, Bride Street and Dublin Street.

- Market square and Bride Street between Market Square and Dublin Street is proposed as a shared use street with temporary bollards to be raised to create a pedestrian only zone on market days.
- The proposed corner radii at the junctions comply with DMURS (Section 4.3.3) of 4.0 – 6.0m in order to reduce vehicular speeds and reduce pedestrian crossing distances.

5.4.3 Carriageway Conditions

- The proposed development's road network maintains the site's 6.5m wide carriageways with the exception of Market Square that is maintained at 5.8m wide.
- Swept Path Analysis has been undertaken, see Appendix F, which demonstrates that the proposed design can cater for servicing vehicles.

6. Trip Reassignment and Distribution

6.1 General

The purpose of this section is to determine the reassignment of trips in terms of vehicular traffic that will be caused by the closure of Bride Street and Market Square.

To understand the potential vehicular trip generation associated with the site, AECOM has undertaken a review of the committed traffic upon the adjoining road network against the proposed trip reassignment, outlined in the subsequent sections.

6.1.1 Proposed Development

In order to determine the potential trip re-distribution for when either Bride Street or Market Square is closed, a matrix estimation exercise was undertaken in LinSig using turning counts. Figure 6.1 and 6.2 shows the reassigned traffic flows for the two scenarios:

Figure 6.1. Traffic Flows – Bride Street Closure

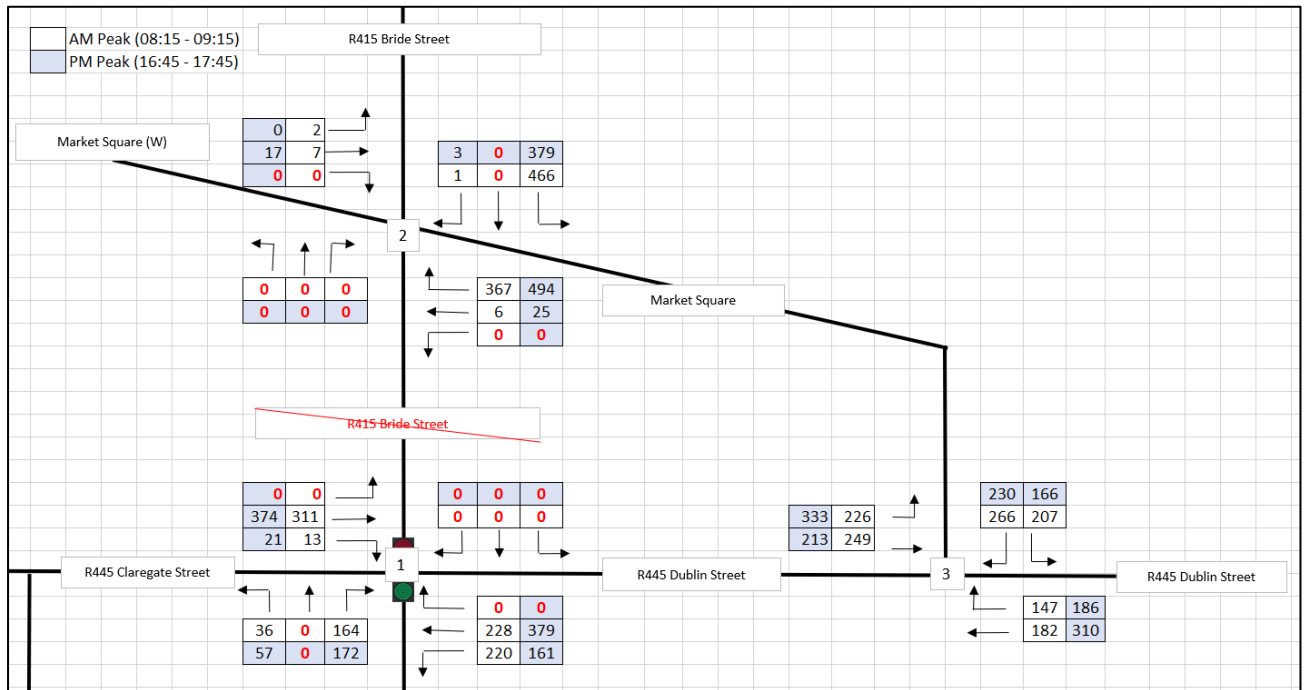
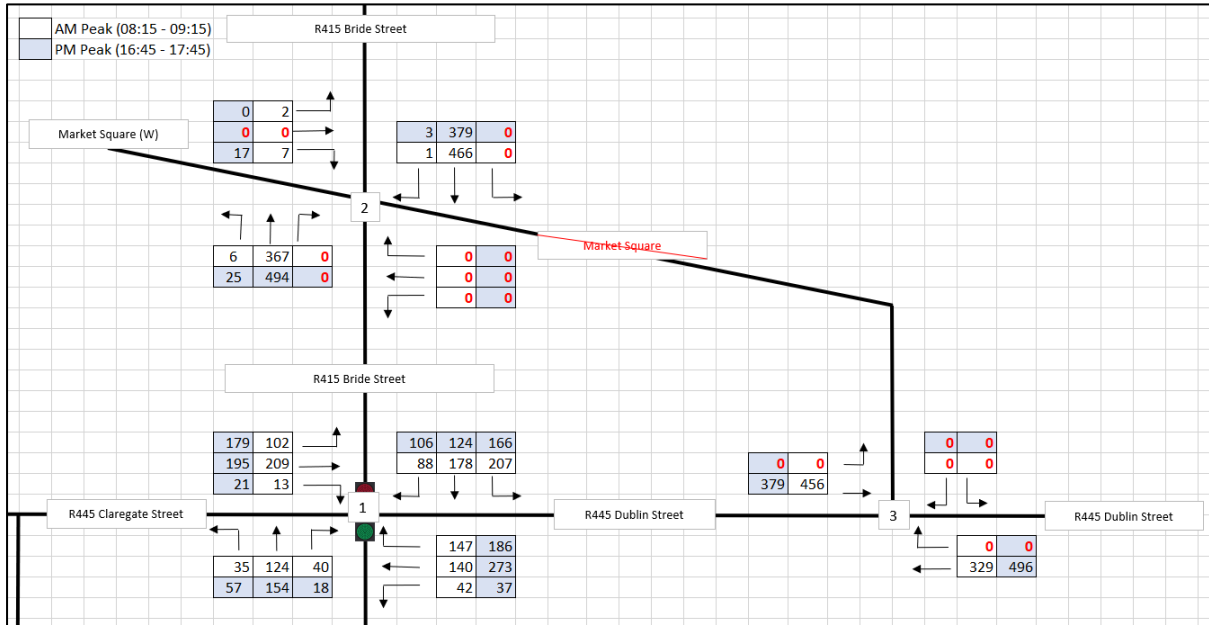

Figure 6.2 Traffic Flows – Market Square Closure



The closure of Bride Street (Figure 6.1) shows increased vehicular traffic travelling Southeast along Market Street and a significant increase in traffic travelling Northwest along Market Square. The closure of Market Square (Figure 6.2) shows increased vehicular traffic travelling North and South along Bride Street as well as increased traffic along Dublin Street. These calculations model a worst case scenario and traffic may be reduced if vehicles decide to take alternative routes or use other modes of transport such as cycling or walking.

6.2 Traffic Growth Rates

This TTA will adopt an Opening Design Year of 2025. In accordance with TII Guidance, Future Design years (+5 and +15 years) of 2030 and 2040 will therefore be adopted.

The TII Project Appraisal Guidelines (PAG) PE-PAG-02017 was utilised to determine the traffic growth forecast rates. The traffic growth forecast rates within the PAG ensures local and regional variations and demographic patterns are accounted for.

Table 6.2 within the PAG provides Link-Base Growth Rates for the different County areas within Ireland. The subject site lies within the Kildare County with the growth factors as outlined within Table 6.1.

Table 6.1 National Traffic Growth Forecasts: Annual Growth Factors

County	Low Sensitivity Growth Rates				Central Growth Rates				High Sensitivity Growth Rates			
	2016-2030		2030-2040		2016-2030		2030-2040		2016-2030		2030-2040	
	LV	HV	LV	HV	LV	HV	LV	HV	LV	HV	LV	HV
Kildare	1.0180	1.0363	1.0044	1.0135	1.0197	1.0378	1.0062	1.0155	1.0229	1.0413	1.0107	1.0283

Source: extract from Table 6.2 PE-PAG-02017

Applying the annual factors (central growth) as outlined in Table 6.1 for the adopted Opening Year of 2024 and Future Horizon Years of 2029 (+5 years) and 2039 (+15 years), the following growth rates have been adopted to establish corresponding baseline network flows:

- 2022 to 2024 – 1.0124 (or 1.24%);
- 2022 to 2029 – 1.0442 (or 4.42%); and
- 2022 to 2039 – 1.0939 (or 9.39%).

The 'baseline' Do-Nothing traffic movements for the periods 2024, 2029 and 2039 are presented in Appendix G.

6.3 Threshold Analysis

The redistributed trips associated with the proposed development have been reviewed against the base flows on the local road network, and the resulting percentage impact is shown in Table 6.2 and Table 6.3.

Table 6.2 Percentage Impacts AM

Junction	Current	Bride Street Closure	Impact	Market Square Closure	Impact
Bride Street/ Dublin Street	992	972	-2%	1325	34%
Bride Street/Market Square	877	849	-3%	849	-3%
Dublin Street/ Market Square	816	1277	56%	918	-4%

Table 6.3 Percentage Impacts PM

Junction	Current	Bride Street Closure	Impact	Market Square Closure	Impact
Bride Street/ Dublin Street	1228	1164	-5%	1516	23%
Bride Street/Market Square	964	918	-5%	918	-5%
Dublin Street/ Market Square	934	1438	54%	875	-6%

The closure of Bride Street has the largest impact on the Dublin Street/Market Square junction. This is due to the traffic being redirected from Bride Street to Market Square. There is a slightly lower impact on the other two junctions as vehicles would no longer be able to travel on Bride Street resulting in one less arm being used at the Bride Street/Dublin Street and Bride Street/Market Square junctions.

The closure of Market Square has the largest impact on the Bride Street/Dublin Street junction. This is due to the traffic being redirected from Market Square to Bride Street therefore having a greater impact on this junction. There is a slightly lowered impact on the other two junctions as vehicles would no longer be able to travel on Market Square resulting in one less arm being used at the Bride Street/Market Square and Dublin Street/Market Square junctions.

6.4 Summary

This chapter has outlined the methodology adopted to determine trip redistribution used for the theoretical traffic levels for the proposed development and this data has been used within further assessment of the network which is highlighted in the following Chapters of this report.

7. Junction Impact Analysis

7.1 Introduction

This chapter presents the impact analysis to identify the potential effects of the proposed development upon the surrounding road network at the junctions as identified in Chapter 6 of this report.

PICADY from the TRL software Junctions 10 have been used to model the operations of the priority junctions, with the geometric parameters and observed traffic flow at each junction entered into the computer package. Within the modelling software, the time periods assessed are divided into a number of 15-minute time segments in order to simulate the likely arrival pattern of traffic more effectively. The results returned in the models are the Ratio of Flows to Capacity (RFC) and queue (PCU). The maximum RFC value for each movement is likely to be observed over the central 15- 30-minute period of the hour under consideration.

RFC values between 0.00 and 0.85 are generally accepted as representing stable operating conditions, values between 0.85 and 1.00 represent variable operation (i.e. possible queues building up at the junction during the period under consideration and increases in vehicle delay moving through the junction). RFC values in excess of 1.00 represent overloaded conditions (i.e. congested conditions).

Queues are measured in Passenger Car Units (PCU), a Passenger Car Unit is a measure used primarily to assess highway capacity, for modelling purposes. Different vehicles are assigned different values, according to the space they take up on a road. A car has a value of 1; smaller vehicles such as motorcycle will have lower values, and larger vehicles such as HGVs will have higher values. Table 7.1 illustrates the PCU conversion values used.

Table 7.1 PCU Values

Vehicle Type	PCU Value
Pedal Cycle	0.2
Motorcycle	0.4
Car	1.0
Light Goods Vehicle (LGV)	1.0
Medium Goods Vehicle (MGV)	1.9
Heavy Goods Vehicle (HGV)	2.5
Buses and Coaches	2.0

LinSig is used to model the operation of signalised junctions and reports a Degree of Saturation (DoS) for each link (i.e. demand / available capacity) and Mean Max Queue (MMQ) recorded in Passenger Car Units (PCUs). A DoS between 0% and 90% is generally considered as representing stable operating conditions, values between 90% and 100% represents a constrained scenario (i.e. possible queues building up at the junction and increases in vehicle delay). A DoS beyond 100% represents overloaded conditions and a junction working beyond theoretical capacity. LinSig provides an overall Practical Reserve Capacity (PRC) is a commonly used measure of its available spare capacity. It is related to the degree of saturation of a traffic signal junction, Positive numbers present potential spare capacity and negative numbers presents potential over capacity issues.

Junctions 10 software requires flows to be in PCUs and for HGVs proportions to be included within each model. The idea is the model takes the speed of the HGV into account which allows for the delay and queue to be represented correctly. For all capacity assessments HGV flows from Automatic Traffic Counts have been used.

7.2 Scenarios

For all junctions, four scenarios have been modelled:

- Base – using 2022 data this scenario is illustrating existing conditions.

- Bride Street Closure – this scenario illustrates the junction impact with the closure of Bride Street between Market Square and R445 Dublin Street for the future year of 2024, 2029 and 2039.
- Market Square Closure – this scenario illustrates the junction impact with the closure of Market Square between Bride Street and R445 Dublin Street for the future year of 2024, 2029 and 2039.

All junctions assessed have been validated using observed queue data. All scenarios have been tested during the AM and PM Peak:

- AM Peak – 08:15 – 09:15
- PM Peak – 16:45 – 17:45

All junction impact results are provided in Appendix H.

7.3 Junction Analysis

7.3.1 Bride Street / Dublin Street Junction

The layout of Bride Street / Dublin Street Junction is outlined in Figure 7.1

Figure 7.1 Bride Street / Dublin Street Junction Layout

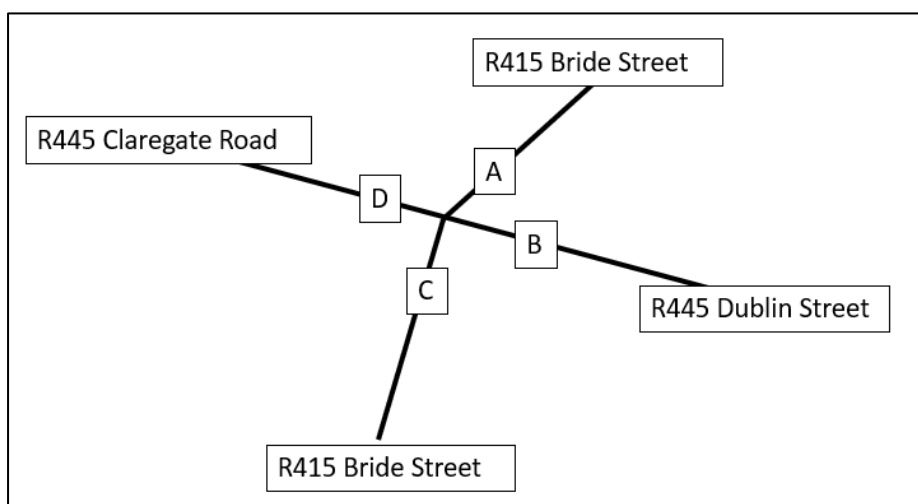

Queue surveys were undertaken by Irish Traffic Surveys for the Bride Street / Dublin Street Junction. Queue lengths were recorded in metres. To convert to PCU's these measurements were divided by 5.75m. Average, Maximum and Minimum Queue Length for the AM and PM peaks are shown in Table 7.2.

Table 7.2 Bride Street / R445 Dublin Street Observed Queue Data (PCUs)

Arm	AM			PM		
	Average	Max	Min	Average	Max	Minimum
A - Bride Street North Left Ahead Right	5	6	2	5	6	3
B - Dublin Street East Right Left Ahead	4	7	2	6	10	4
C - Bride Street South Ahead Right Left	4	6	3	6	8	4
D - Dublin Street West Left Ahead Right	6	9	3	7	10	4

The junction has been assessed using LinSig software to establish whether or not it can accommodate redirected traffic if Market Square and Bride Street were to be closed. DoS% and MMQ results can be seen in Table 7.3.

Table 7.3 Bride Street / R445 Dublin Street Base Scenario

Arm	AM		PM	
	DoS %	MMQ	DoS%	MMQ
Base Model				
Bride Street North Left Ahead Right	76.6	6.1	85.7	6.4
Dublin Street East Right Left Ahead	44.0	2.9	67.3	6.0
Bride Street South Ahead Right Left	53.0	3.5	82.1	5.9
Dublin Street West Left Ahead Right	83.6	7.5	88.1	9.8
PRC		7.7		2.2
Delay (pcuHr)		11.02		16.80
Cycle Time (s)		60		60

Table 7.3 shows all arms are below 90% degree of saturation and all queues are within the existing length of the lane. The LinSig queues are comparable to the observed queues and therefore consider the base model to be representative and suitable for further testing of future scenarios. Model results of future scenarios are shown in Figure 7.4.

Table 7.4 Future scenarios of Bride Street / R445 Dublin Street junction assessment

Arm	2024 AM		2024 PM		2029 AM		2029 PM		2039 AM		2039 PM	
	DoS (%)	MMQ	DoS (%)	MMQ	DoS (%)	MMQ	DoS (%)	MMQ	DoS (%)	MMQ	DoS (%)	MMQ
2024 Bride Street Closure												
Bride Street North	0.0	0.0	0.0	0.0	0.0	0.0	0.0	0.0	0.0	0.0	0.0	0.0
Dublin Street East	83.1	9.3	95.8	16.0	76.0	9.5	87.6	13.4	79.6	10.3	91.8	15.6
Bride Street South	83.3	5.5	95.9	9.3	71.8	5.0	82.7	6.7	74.9	5.4	86.1	7.4
Dublin Street West	53.9	5.0	66.2	6.6	49.4	5.6	60.4	7.3	51.6	5.9	63.2	7.8
PRC	8.0		-6.6		18.5		2.8		13.1		-2.0	
Delay	10.50		20.37		9.07		13.50		9.99		16.07	
Cycle Time	60		60		70		70		70		70	
Market Street Closure												
Bride Street North	93.9	15.9	99.8	19.8	90.8	16.0	98.4	20.0	90.5	17.8	98.2	21.2
Dublin Street East	91.0	11.3	97.1	20.3	90.0	12.0	97.2	22.3	91.8	14.1	98.7	23.0
Bride Street South	44.4	3.9	51.2	5.5	52.5	4.5	50.2	6.1	58.3	5.2	49.4	6.5
Dublin Street West	61.3	7.0	58.0	8.5	59.0	7.8	57.0	9.4	58.5	8.8	59.8	10.5
PRC	-4.4		-10.9		-0.8		-9.4		-2.0		-9.6	
Delay	20.88		31.26		20.27		31.58		22.42		33.56	
Cycle Time	80		90		90		100		100		105	

Table 7.4 illustrates that both the closure of Bride Street and the closure of Market Square independently would lead to Degrees of saturation over 90% on some arms within the first year of opening (2024). It is understood the junction would operate on MOVA which would switch the green time demand to the arms with the most traffic. As LinSig only provides a static representative of the model cycle times have been increased to keep the degree of saturation below 100%.

It is important to remember, the results for the road closures is temporary and for a limited time of the day. It also assumes all traffic redirects to nearby roads when in reality traffic will naturally redistribute and either reroute way from the square or chose not to travel here on market days.

For all scenarios, the LinSig shows the queue on bride street would surpass the Market Street junction to the north. This can be managed with further tweaks to the cycle time.

7.3.2 Bride Street / Market Square Junction

The model orientation of Bride Street / Dublin Street Junction is outlined in Figure 7.2.

Figure 7.2 Bride Street / Market Square Junction Layout

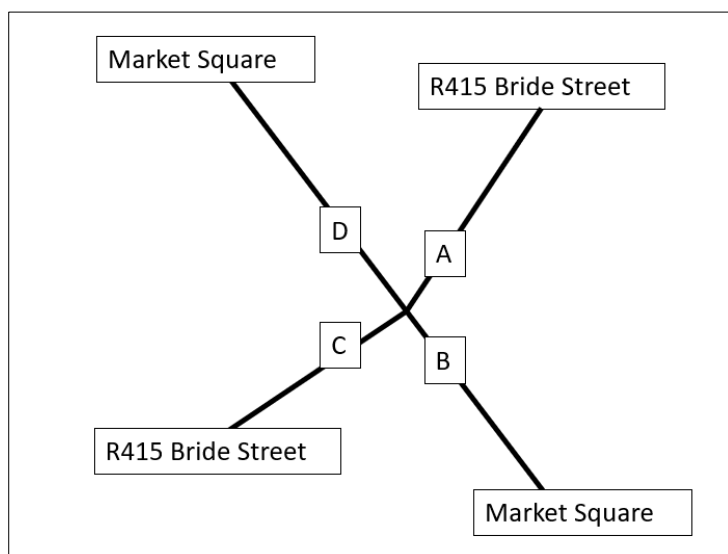

Observed Queue Data was taken by Irish Traffic Surveys for the Bride Street / Market Square Junction. Queue counters were set at three of the arms and the observed queue lengths were recorded in metres. To convert to PCU's these measurements were divided by 5.75m. Average, Maximum and Minimum Queue Length for the AM and PM peaks are shown in Table 7.5.

Table 7.5 Bride Street / Market Square Observed Queue Data (PCUs)

Column heading	AM			PM		
	Average	Max	Min	Average	Max	Minimum
Stream A – BCD Bride Street North	-	-	-	-	-	-
Stream B – ACD Market Square East	3	5	1	4	7	3
Stream C – ABD Bride Street South	2	5	0	2	5	0
Stream D – BCD Market Square West	0	1	0	1	3	0

~ No Queues were recorded.

A base model of the junction has been assessed using Junctions 10 software to establish the current operation of the junction. Results are shown in Table 7.6.

Table 7.6 Bride Street / Market Square

Arm	AM		PM	
	RFC	Queue	RFC	Queue
2022 Base Model				
Stream A – BCD Bride Street North	0.00	0.0	0.01	0.0
Stream B – ACD Market Square East	0.43	0.7	0.58	1.3
Stream C – ABD Bride Street South	0.03	0.0	0.04	0.1
Stream D – BCD Market Square West	0.03	0.0	0.06	0.1

Table 7.6 shows all arms are below 0.85 RFC and all queues are within the existing length of the lane. The Junction 10 queues are comparable to the observed queues and therefore consider the base model to be representative and suitable for further testing of future scenarios. Model results of future scenarios are shown in Table 7.7.

Table 7.7 Future scenarios of Bride Street / Market Square junction assessment

Arm	2024 AM		2024 PM		2029 AM		2029 PM		2039 AM		2039 PM	
	RFC	MMQ	RFC	MMQ	RFC	MMQ	RFC	MMQ	RFC	MMQ	RFC	MMQ
Bride Street Closure												
Stream A – BCD Bride Street North	0.00	0.0	0.01	0.0	0.0	0.0	0.01	0.0	0.00	0.0	0.01	0.0
Stream B – ACD Market Square East	0.89	6.4	1.22	63.3	1.22	7.7	1.26	77.7	0.97	11.9	1.33	102.6
Stream C – ABD Bride Street South	0.00	0.0	0.00	0.0	0.0	0.0	0.00	0.0	0.00	0.0	0.00	0.00
Stream D – BCD Market Square West	0.02	0.0	0.04	0.0	0.02	0.0	0.05	0.0	0.03	0.0	0.05	0.01
Market Street Closure												
Stream A – BCD Bride Street North	0.00	0.0	0.01	0.0	0.00	0.0	0.01	0.0	0.00	0.0	0.01	0.0
Stream B – ACD Market Square East	0.00	0.0	0.00	0.0	0.00	0.0	0.00	0.0	0.00	0.0	0.00	0.0
Stream C – ABD Bride Street South	0.00	0.0	0.00	0.0	0.00	0.0	0.00	0.0	0.00	0.0	0.00	0.0
Stream D – BCD Market Square West	0.03	0.0	0.06	0.1	0.03	0.0	0.07	0.1	0.03	0.0	0.07	0.01

Table 7.7 illustrates that the Market Square East arm would operate over capacity when Bride Street is closed in all scenarios. It is important to note, once an RFC is reached 1.0 the queue increases exponentially and therefore the queues presented in the table are not wholly representative of what would happen on site.

It is likely 100% of traffic travelling on bride street would not redirect onto Market square but we have modelled this scenario as a worst case scenario. The closure of Market Street shows the junction would continue to operate within capacity.

7.3.3 R445 Dublin Street / Market Square Junction

The orientation of the Market Square / Dublin Street Junction is outlined in Figure 7.3.

Figure 7.3 R445 Dublin Street / Market Square Junction Layout

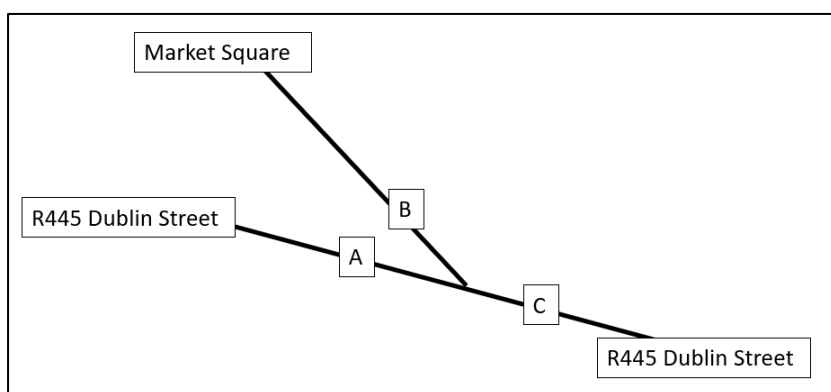

Observed Queue Data was taken by Irish Traffic Surveys for the Junction. Queue counters were only set at the Market Square arm of the junction and the observed queue lengths were recorded in metres. To convert to PCU's these measurements were divided by 5.75m. Average, Maximum and Minimum Queue Length for the AM and PM peaks are shown in Table 7.8.

Table 7.8 R445 Dublin Street / Market Square Observed Queue Data (PCU's)

Column heading	AM			PM		
	Average	Max	Min	Average	Max	Minimum
Stream A – BC Market Square	1	4	0	3	5	0
Stream B – AC Dublin Street East	~	~	~	~	~	~
Stream C – AB Dublin Street West	~	~	~	~	~	~

~ No Queues were recorded.

Table 7.9 R445 Dublin Street / Market Square Base Results

Arm	AM		PM	
	RFC	Queue	RFC	Queue
2021 Base Model				
Stream B-C Market Sq Left	0.30	0.4	0.26	0.4
Stream B-A Market Sq Right	0.04	0.0	0.06	0.1
Stream C-AB Dublin St East Ahead / Right	0.31	0.6	0.45	1.2

Table 7.9 shows all arms are below 0.85 RFC and all queues are within the existing length of the lane. The Junction 10 queues are comparable to the observed queues and therefore consider the base model to be representative and suitable for further testing of future scenarios. Model results of future scenarios are shown in Table 7.10.

Table 7.10 R445 Dublin Street / Market Square Market Junction Assessment

Arm	2024 AM		2024 PM		2029 AM		2029 PM		2039 AM		2039 PM	
	RFC	MMQ	RFC	MMQ	RFC	MMQ	RFC	MMQ	RFC	MMQ	RFC	MMQ
Bride Street Closure												
Stream B-C Market Sq Left	0.47	0.9	0.37	0.6	0.50	1.0	0.39	0.6	0.56	1.2	0.43	0.7
Stream B-A Market Sq Right	0.66	1.8	0.60	1.5	0.69	2.1	0.62	1.6	0.73	2.6	0.67	1.9
Stream C-AB Dublin St East Ahead/Right	0.34	0.7	0.50	1.4	0.36	0.7	0.51	1.5	0.38	0.8	0.55	1.8
Market Street Closure												
Stream B-C Market Sq Left	0.00	0.0	0.00	0.0	0.00	0.0	0.00	0.0	0.00	0.0	0.00	0.0
Stream B-A Market Sq Right	0.00	0.0	0.00	0.0	0.00	0.0	0.00	0.0	0.00	0.0	0.00	0.0
Stream C-AB Dublin St East Ahead/Right	0.00	0.0	0.00	0.0	0.00	0.0	0.00	0.0	0.00	0.0	0.00	0.0

Table 7.10 illustrates that the junction in all scenarios will operate within capacity. When Bride Street is closed, the junction will see minor queues on all arms. The reason for zero RFCs and Queues in the Market Street closure scenario is there is no traffic giving way which means there is no conflict within the model. With no conflict Junctions 10 will not provide a result.

7.3.4 Junction Analysis Summary

This section has illustrated the future impacts of each of the two main scenarios, the closure of Market Square, the closure of Bride Street. The results show the Bride Street closure has the most impact, however it should be noted these models assess a worst case scenario whereby all traffic redistributes to the next junction. In reality this is unlikely to happen.

8. Road Safety Audit – Designers Response

8.1 RSA

A Road Safety Audit was undertaken by Norman Bruton and Owen O’Reilly (both TII Auditor Approved) on 25th October 2023. The Stage 1 Road Safety Audit has been carried out in accordance with the requirements of TII Publication Number GE-STY-01024, dated December 2017. The problems identified in this report are considered to require action in order to improve the safety of the scheme for road users. The full RSA Stage 1 Report is provided in Appendix I.

8.2 RSA Designers Response

This section will look at the problems identified within the Stage 1 Road Safety Audit and present the recommendations and accepted changes required. The RSA problem drawing is presented in Appendix I.

8.2.1 Problem 3.1

Location - Drawing 60594179-ACM-00-XX-SK-CE-10-0006 Rev C, Rising bollards.

Problem - It is proposed to provide rising bollards to prevent access on market days. Drivers unfamiliar with the area may not see the bollards until they have turned off the R445 which could lead to reversing manoeuvres and possible rear-end collisions.

Recommendation - It is recommended that suitable signage is provided to warn drivers of the restricted traffic movements during market days. The signalised junction at Bride Street (South) should not give conflicting signal information with allowable movements during market days.

AECOM Response

Drawings 60594179-ACM-00-XX-SK-CE-10-1007, 60594179-ACM-00-XX-SK-CE-10-1008 and 60594179-ACM-00-XX-SK-CE-10-1009 have been provided in Appendix I showing potential locations for temporary signage to inform road users about road closures and forbidden turns that can be erected during market days. The proposed temporary signs would give enough warning for road users to adjust their movements before approaching junction. Figures 8.1 show the proposed signs to be used.

Figure 8.1 Temporary signage required.



Figure 8.2 shows the potential locations of temporary signage when Bride Street is closed.

Figure 8.2 Temporary Signage – Bride Street Closure

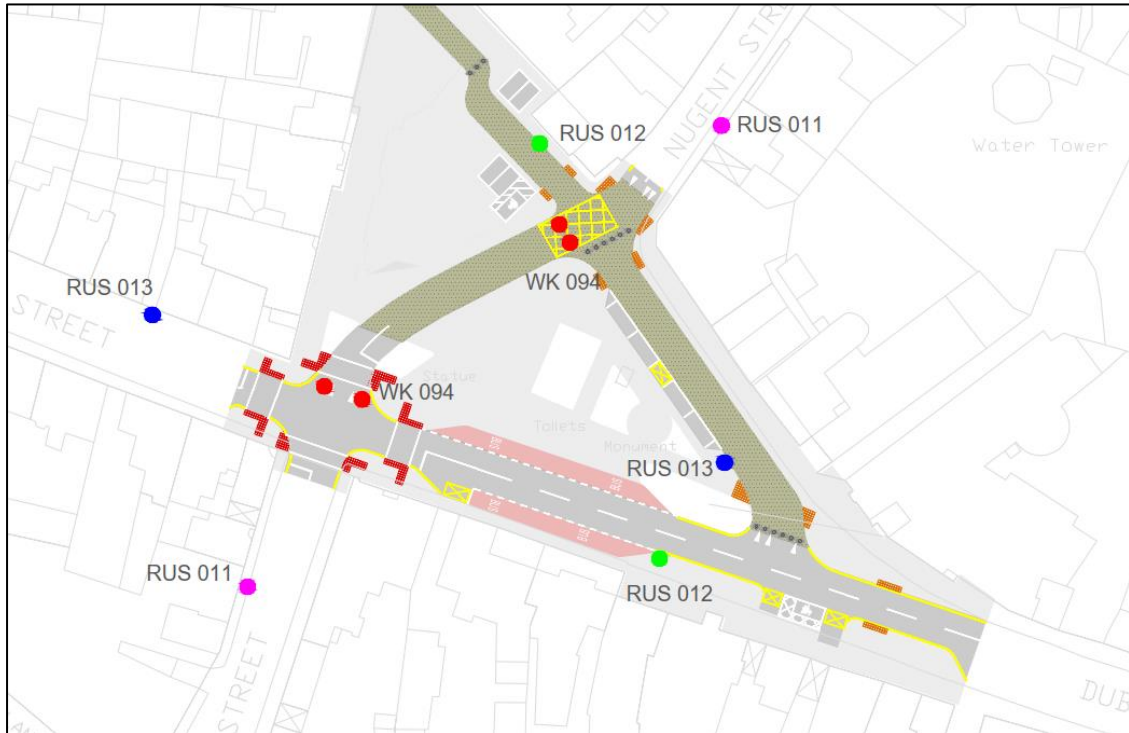

Source: AECOM Drawing 60594179-ACM-00-XX-SK-CE-10-1007

Figure 8.3 shows potential locations of temporary signage when Market Square is closed.

Figure 8.3 Temporary Signage – Market Square Closure

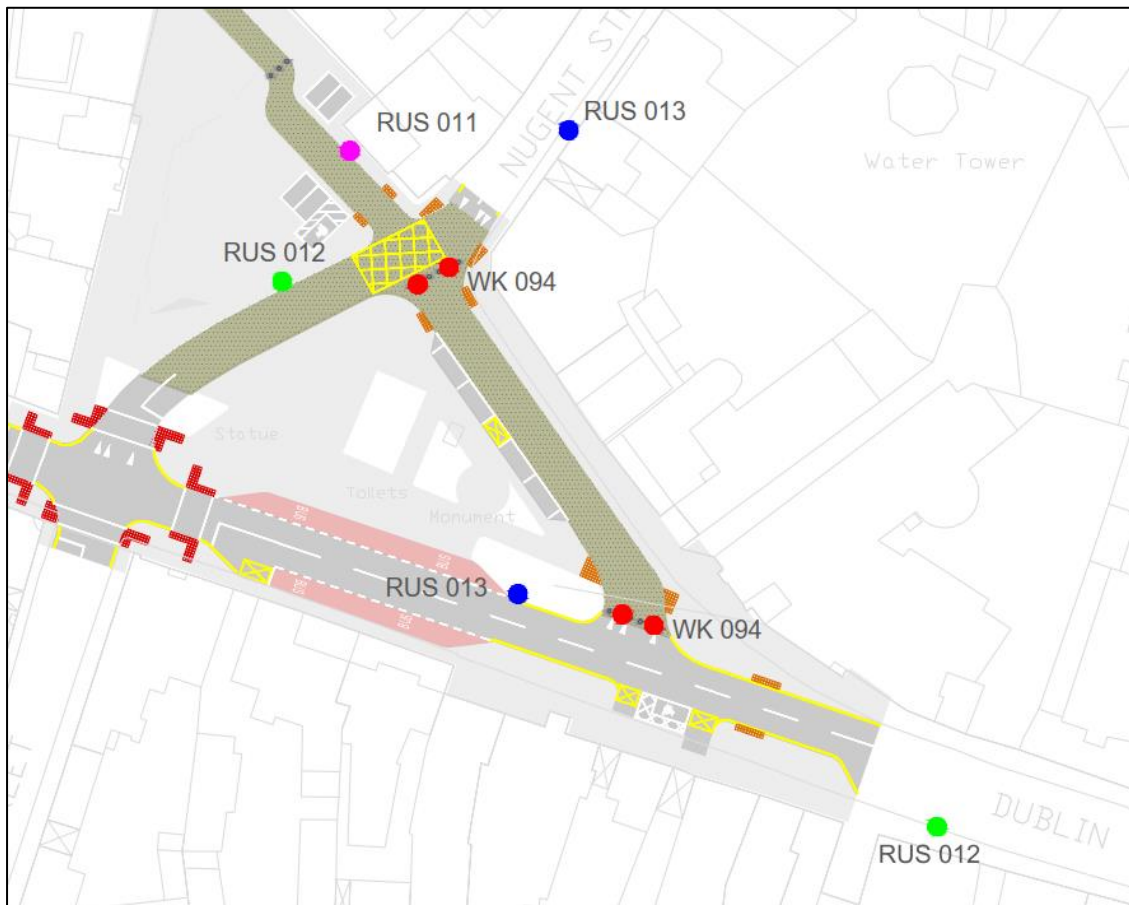

Source: AECOM Drawing 60594179-ACM-00-XX-SK-CE-10-1008

8.2.2 Problem 3.2

Location - Drawing 60594179-ACM-00-XX-SK-CE-10-0006 Rev C, Rising bollards, Nugent Street.

Problem - If a driver travels towards Market Square from Nugent Street and the bollards are risen they may not have room to turn and travel back. This could lead to collisions with vulnerable road users, street furniture or buildings.

Recommendation - It is recommended that a warning system for road closure on Market days be provided at the previous junction(s) to ensure drivers do not travel on Nugent Street to Market Square.

AECOM Response

Drawings 60594179-ACM-00-XX-SK-CE-10-1007, 60594179-ACM-00-XX-SK-CE-10-1008 and 60594179-ACM-00-XX-SK-CE-10-1009 have been provided in Appendix I showing potential locations for temporary signage to inform road users about road closures and forbidden turns that can be erected during market days. The proposed temporary signs would give enough warning for road users to adjust their movements before approaching junction. Figures 8.1 to 8.3 can be seen for the above response relating to this issue.

8.2.3 Problem 3.3

Location - Drawing 60594179-ACM-00-XX-SK-CE-10-0002 Rev A, Swept path analysis, R445/Bride Street Junction

Problem - The swept path analysis for the refuse vehicles shows overlap close to the stop line of the proposed signalised junction. If one wide vehicle is stopped at the signals another will not be able to undertake the turn. This could lead to side-swipe collisions. Many large vehicles were observed at this location during the site visit.

Recommendation - Ensure sufficient space is provided at the signalised junction for turning vehicles assuming that other vehicles are waiting at the stop line. Vehicles larger than refuse vehicles may be undertaking these manoeuvres, the articulated vehicle swept path analysis only shows a single movement. Stop lines may need to be set back on a weight restriction be provided and alternative routes for larger vehicles.

AECOM Response

Swept paths at the R445/Bride Street Junction have been revised to check there is sufficient space at the signalised junction for turning vehicles assuming that other vehicles are waiting at the stop line. Swept path has also been separated based on the two phases of the signalised junction to give a clearer view of which vehicles movements will be taking part simultaneously. This can be seen in Figures 8.4 and 8.5, and can be seen in the drawing 60594179-ACM-00-XX-SK-CE-10-0002 in Appendix F.

Figure 8.4 Proposed Swept Path with Large Refuse Vehicle

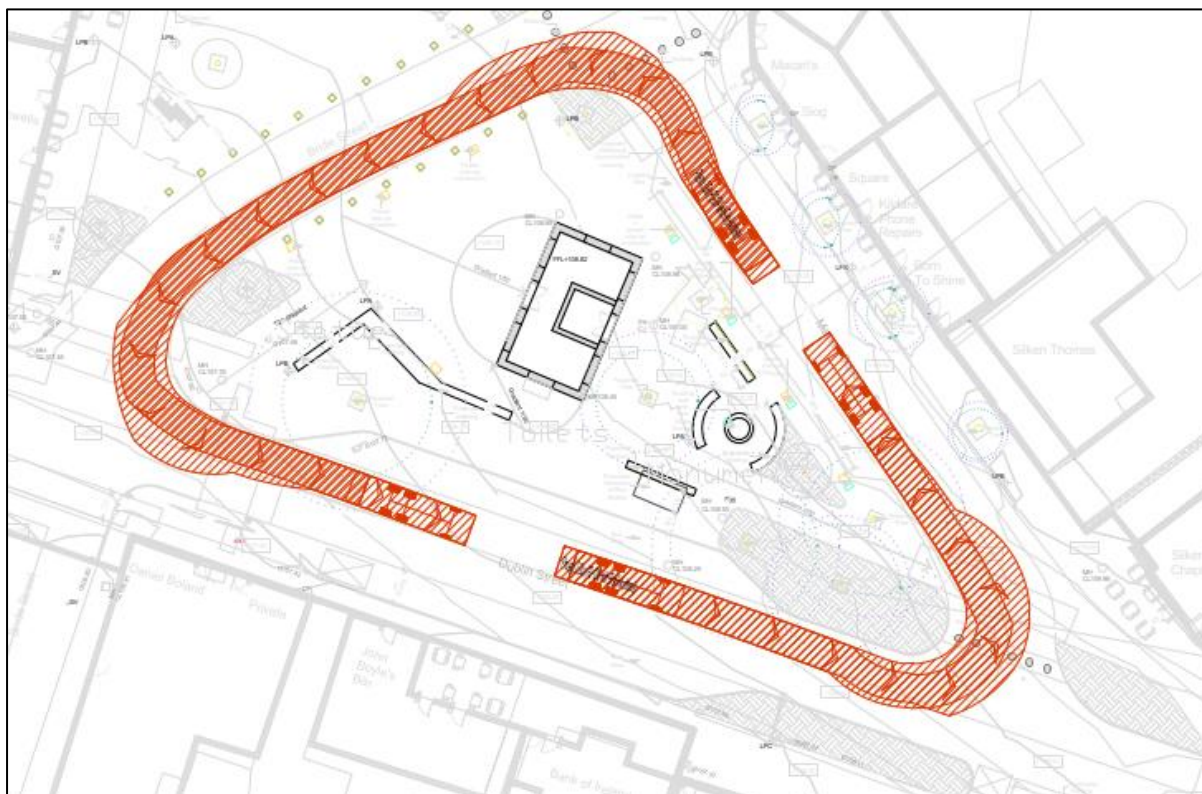

Source: AECOM drawing 60594179-ACM-00-XX-SK-CE-10-0002

Figure 8.5 Proposed Swept Path with Large Refuse Vehicle

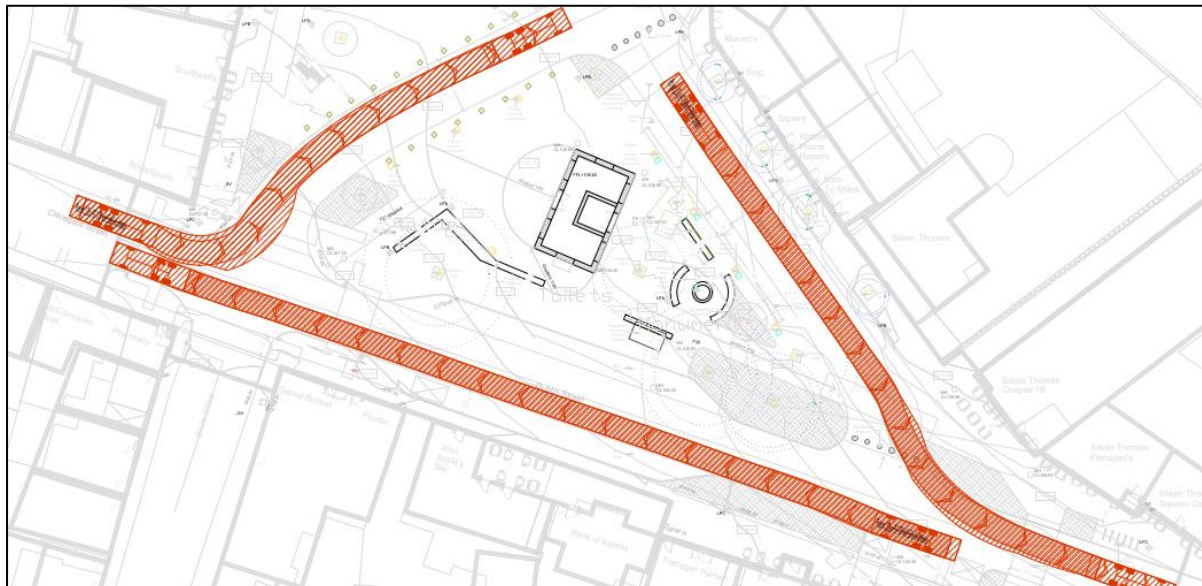

Source: AECOM drawing 60594179-ACM-00-XX-SK-CE-10-0002

8.2.4 Problem 3.4

Location – Drawing 60594179-ACM-00-XX-SK-CE-10-0006 Rev C, Shared Surface.

Problem - The shared use surface terminates on approach to the signalised junction on Bride Street (North). Blind or partially sighted pedestrians may not know that they are leaving a shared use area which could lead to collisions with vehicles whose drivers do not expect such movements.

Recommendation – It is recommended that suitable tactile paving or other features be provided to denote the end of the Shared use surfacing at all locations where it terminates.

AECOM Response

Bollards (and planters) will be provided along the footway edge to demarcate the difference between the carriageway and the footway. On market days removable bollards are being provided across the carriageway which will prevent vehicular traffic and also warn pedestrians of the end of the shared area. Tactile paving will be extended to building line and guidance path surface to be provided along the edge of the pedestrian route, south to the planters and to meet the red tactile paving generally to a depth of 800mm. For clarity it will not be provided across the carriageway to ensure that pedestrians can safely and correctly use the crossing on non-market days. Updates to the tactile paving at the crossing can be seen in Figure 8.6 and an example of the warning paving for the carriageway edge in Figure 8.7. This is also reflected in the updated drawing 60594179-ACM-00-XX-SK-CE-10-0006 which is attached in Appendix E.

Figure 8.6 Extended tactile paving at crossing and warning tactile paving along edge of carriageway.

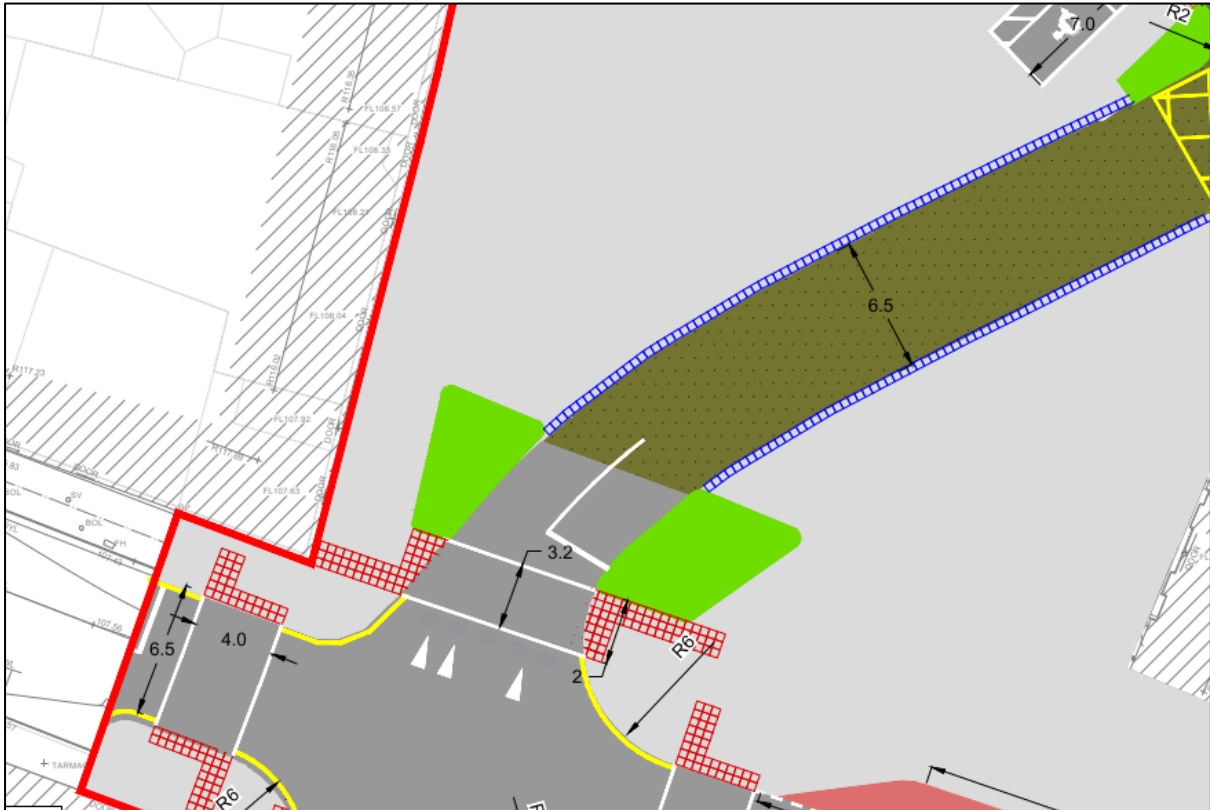

Source: AECOM Drawing 60594179-ACM-00-XX-SK-CE-10-0006

Figure 8.7 Example tactile paving for carriageway edge Dimensions 400 x 400

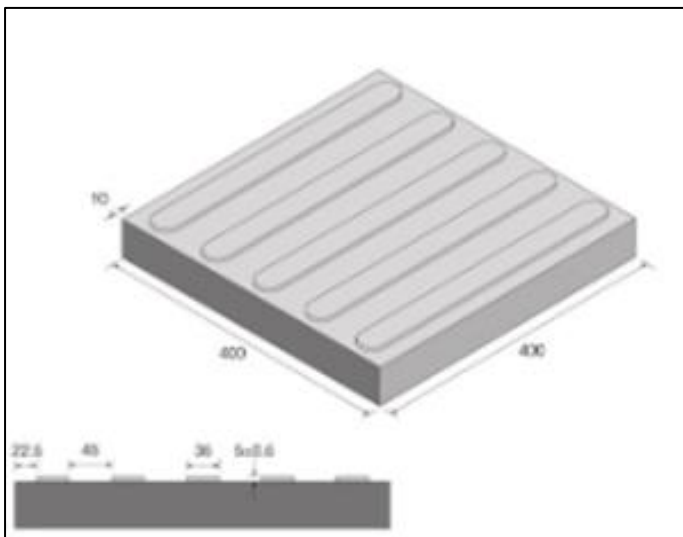

8.2.5 Problem 3.5

Location – Drawing 60594179-ACM-00-XX-SK-CE-10-0006 Rev C, & 60594179-ACM-00-XX-SK-CE-10-0002 Rev A, Swept path analysis Parking spaces on Market Square.

Problem - There are four parking spaces on Market Square. The two standard sized spaces are located off a proposed 4.8m shared use street. This may lead to difficulty for drivers to get into and out of the spaces if the adjacent spaces are occupied. It was noted that these spaces are currently reserved as age friendly and for those with hidden disabilities and if retained for such use the drivers may be somewhat mobility impaired. Although the swept path analysis is provided it is unclear how easily these movements can be undertaken.

Recommendation – It is recommended that suitably sized parking spaces be provided for their intended use.

AECOM Response

Swept paths for cars using the provided parking spaces have been shown more clearly in the updated 60594179-ACM-00-XX-SK-CE-10-0001 drawing which can be found in Appendix F.

8.2.6 Problem 3.6

Location: Site Observation. ESB pole at proposed crossing.

Problem: There is a large ESB pole close to the proposed pedestrian crossing on the western side of the Bride Road Junction with the R445. This could reduce the effective width of the footpath for pedestrians, especially the mobility impaired leading to some stepping onto the carriageway where they would be at greater risk of being struck by passing/turning vehicles.

Recommendation: It is recommended that the pole be relocated or the services provided underground.

AECOM Response:

The services will be provided underground and therefore the pole will be removed.

9. Summary and Conclusions

9.1 Summary

AECOM has been commissioned by Kildare County Council (KCC) to provide a Traffic and Transport Assessment (TTA) in support of the planning application for a part 8 public realm redevelopment of Kildare Market Square in Kildare town, Co. Kildare

Kildare County Council have a vision to regenerate the Market Square into a public realm space for the community. It is proposed to improve the existing road and pedestrian network of the square by increasing pedestrian crossing widths, removing parking bays and extending bus stop laybys. It is proposed to install a combination of temporary and retractable bollards on Bride Street and Market Square to allow one or both roads to be closed during market days or special events.

This TTA has demonstrated the existing context and background conditions of the site, its accessibility and the potential impacts as a result of the development.

Accessibility of the site by sustainable transport modes has been assessed. This TTA has demonstrated the feasibility of walking as a means of transport from Kildare Market Square to various local amenities and how the proposed closure of the two roads on market days will further improve the attractiveness of walking to and from the market square.

In regard to cycling, the site does not currently have any existing cycle facilities so this is something that will be addressed by the proposed development by added cycle parking in the area and increased shared use space in the market square which will make the space safer and more attractive for cyclists. The site currently has nearby bus stops with good access to nearby areas. The proposals include new cycle racks to be dispersed across the square.

The travel characteristics of the proposed development have been assessed. Trip redistribution has been utilised from the recorded junction turning counts and three key junctions have been evaluated using LinSig and Junction 10 software. Future scenarios have also been evaluated.

Any issues raised in the Stage 1 Road Safety Audit have also been addressed and changes made where appropriate.

9.2 Conclusion

The Market Square sits at the heart of Kildare and host weekly market days. In order to make these days safer and more accessible for pedestrians and cyclists, the effects of the closure of certain roads on Market day has been evaluated to see if other junctions in the network can cope with the redistributed traffic. The closure of these roads would show a temporary impact on the operation of other junctions in the network.

However the improvements to pedestrian and cycling facilities, including cycle parking and improved crossing facilities is in line with the National and local policy for the area which advocates for a more sustainable and cleaner future for Ireland and the town of Kildare. Therefore, planning permission should not be withheld for this application on transport or road network safety grounds.

Appendix A Existing Traffic Data

Survey Name: 2017 - 2018
Start: 01/01/2017
End: 31/12/2018
Survey ID: 123456

Irish Traffic Surveys



Survey ID	Survey Name	Start Date	End Date	Location	Survey Type	Status	Created By	Last Modified	Version
1	Survey 1	2017-01-01	2017-12-31	Location A	Survey Type A	Completed	User A	2018-01-01	1.0
2	Survey 2	2018-01-01	2018-12-31	Location B	Survey Type B	In Progress	User B	2018-12-31	1.0
3	Survey 3	2017-01-01	2017-12-31	Location C	Survey Type A	Completed	User A	2018-01-01	1.0
4	Survey 4	2018-01-01	2018-12-31	Location D	Survey Type B	In Progress	User B	2018-12-31	1.0
5	Survey 5	2017-01-01	2017-12-31	Location E	Survey Type A	Completed	User A	2018-01-01	1.0
6	Survey 6	2018-01-01	2018-12-31	Location F	Survey Type B	In Progress	User B	2018-12-31	1.0
7	Survey 7	2017-01-01	2017-12-31	Location G	Survey Type A	Completed	User A	2018-01-01	1.0
8	Survey 8	2018-01-01	2018-12-31	Location H	Survey Type B	In Progress	User B	2018-12-31	1.0
9	Survey 9	2017-01-01	2017-12-31	Location I	Survey Type A	Completed	User A	2018-01-01	1.0
10	Survey 10	2018-01-01	2018-12-31	Location J	Survey Type B	In Progress	User B	2018-12-31	1.0

Appendix B General Arrangement Drawing



Revision	Date	Description	Issued	Checked
P1	23.07.23	Issue to landscape and Civils for review	ADD	
P2	23.07.23	Issued to Conservation Architect for review	ADD	
P3	23.07.23	Issued to Landscape for review	ADD	
P4	23.07.14	Issued to Design Team for coordination	ADD	
P5	23.07.18	Issued to Design Team - received with landscaping and Dublin Road Junction	ADD	
P6	23.07.26	Issued to NCC for review and comment	ADD	
P7	23.11.24	Issued to Design Team for coordination	NC	ADD
P8	23.11.26	Issued to Design Team, final paving	ADD	
P9	23.12.15	Issued to NCC for review and comment	RS	ADD
P10	23.12.23	Barbans on Bride Street removed. Issued to Design Team	RS	ADD



Notes
 Draw scale drawings. All dimensions should be checked on site. Errors to be reported to Architect. To be read in conjunction with all relevant Architect's services and engineers drawings. Contractors, sub-contractors and suppliers must verify all critical dimensions on site prior to fabrication of any building element. Any discrepancies are to be reported to the Architect. The drawings shall be read in conjunction with all relevant specifications, programs and specialist consultant's information. Any discrepancies must be reported to the Architect.
 No information in this drawing/production shall be interpreted as being related to the safety or the performance. As required by the Professional indemnity market we exclude any liability whatsoever for the safety of buildings, products, materials or systems and assume these will be the responsibility of a qualified Engineer and Specialist Contractor Design.
 Copyright © Metropolitan Workshop LLP
 All rights reserved. This drawing should not be used to calculate areas for the purpose of valuation. Do not scale this drawing. All dimensions to be checked on site by the contractor and such dimensions to be shown (this is the contractor's responsibility). All work must comply with the relevant British Standards and Building Regulations. Drawings are the property of Metropolitan Workshop LLP and shall remain their property. This drawing was prepared in part, based on survey information provided by others. Whilst this information is believed to be reliable, Metropolitan Workshop assumes no responsibility for the accuracy of this information or any errors or omissions that may have been incorporated into it as a result of incorrect information provided by others.

Key

	Public Bin		Fire Hydrant		Bus Shelter
	Removable Bin		ESB Box		Bus Shelter
	Fixed Bin		SVC		Bus Shelter
	Bin Socket		M/C		Bus Shelter
	Traffic Light		M/C		Bus Shelter
	PA		M/C		Bus Shelter
	AV		M/C		Bus Shelter

Street Furniture

	Public Bin		Fire Hydrant		Bus Shelter
	Removable Bin		ESB Box		Bus Shelter
	Fixed Bin		SVC		Bus Shelter
	Bin Socket		M/C		Bus Shelter
	Traffic Light		M/C		Bus Shelter
	PA		M/C		Bus Shelter
	AV		M/C		Bus Shelter

Surface Materials

	Proposed Raised Kerb		Natural Stone
	Proposed Flush Kerb (flush surface)		Natural Stone
	Change in zone		Soft Landscaping

Metropolitan Workshop
 Metropolitan Workshop
 14-16 Connaught Street, London
 EC1M 6EG
 00 44 (0) 20 7566 0450
 www.metwork.co.uk

Project: Kildare Market Square Public Realm
Client: Kildare County Council
Location: Kildare Town
Title: Site Layout Plan - Proposed
Date: 23.12.23
Scale: 1:200 @ A0
Drawing Number: 2018 MET ZZ XX DR A 100004 P10

Appendix C Visibility Splay

ISO A1 594mm x 841mm
 Approved: JS
 Checked: HH
 Designer: NO
 Project Management Initials:
 Last saved by: GLEDHILLJ (2023-11-07) Last Picked: 2023-12-01
 Filename: M:\OBS\PR-384133_KILDARE-NEWBRIDGE-TOWN900_CAD_GIS\904_CE01_WIP\05_SKETCHES\2023.11.02_VISIBILITY_SPLAY\60594179-ACM-XX-SK-CE-10-0010.DWG



Water Tower

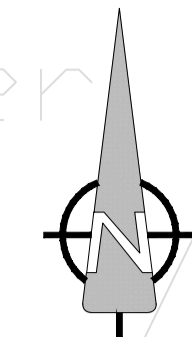

PROJECT
 KILDARE MARKET SQUARE,
 CO. KILDARE

CLIENT
 KILDARE COUNTY COUNCIL

CONSULTANT
 AECOM
 4th Floor Adelphi Plaza,
 George's Street Upper,
 Dun Laoghaire,
 Co Dublin
 Tel: +353 (0)1 6966220
 www.aecom.com

- NOTES**
- THIS DRAWING IS TO BE READ IN CONJUNCTION WITH ALL OTHER RELEVANT ARCHITECTURAL AND ENGINEERING DRAWINGS. ANY DISCREPANCIES, ERRORS OR OMISSIONS TO BE BROUGHT TO THE ATTENTION OF THE DESIGNER.
 - ALL DIMENSIONS TO BE CHECKED BY THE CONTRACTOR ON SITE PRIOR TO COMMENCEMENT OF WORKS.
 - AECOM LIMITED TO BE INFORMED BY THE CONTRACTOR OF ANY DISCREPANCIES PRIOR TO THE COMMENCEMENT OF WORKS ON SITE.
 - DIMENSIONS OF ALL BOUNDARIES AND ADJOINING ROADS TO BE CHECKED ON SITE PRIOR TO COMMENCEMENT OF WORKS.

LEGEND

— VISIBILITY SPLAY



ISSUE/REVISION

IR	DATE	DESCRIPTION

PROJECT NUMBER
 60594179

SHEET TITLE
 VISIBILITY SPLAY
 Market Square

SHEET NUMBER
 60594179-ACM-00-XX-SK-CE-10-0010

Appendix D AECOM Parking Report

Draft

Transmittal
Kildare Town Centre – Parking Kildare Town Centre – Parking Technical Note

Kildare Town Centre – Parking Technical Note

To Kildare County Council	Client Kildare Count Council	Subject Parking Study - Initial Results	Date April 2022
Issued by Brian McMahon	Reason for issue Information	Prepared by Zachary Cave	

1. Introduction

AECOM have been commissioned by Kildare County Council to prepare a technical note regarding the existing parking provision and demand in Kildare Town Centre. Furthermore, occupancy levels were assessed at each car park, over three days based on the parking survey data. This technical note is a high level summary of the observed parking within the study area. A detailed review of the car parking is being undertaken with a more comprehensive report to accompany the Part 8 application.

Parking surveys were undertaken at all the main on-street and off-street parking locations in Kildare Town Centre on Friday the 21st, Saturday the 22nd and Sunday the 23rd of January 2022, over a twelve hour period from 07:00 – 19:00 to capture all peak parking periods.

The on-street and off-street car parking considered as part of this parking assessment are as follows with the locations of the car parks shown in Figure 1.1. In total there are 353 car parking spaces across the 13 car parking locations.

1. Bride Street Car Park (80 spaces)
2. Church Car Park (16 spaces)
3. Nugent Street Car Park (47 spaces)
4. Claregate Street (27 spaces)
5. Market Square (12 spaces)
6. Main Street (23 spaces)
7. Cleamore Road (32 spaces)
8. Fire Castle Lane (9 spaces)
9. Silken Thomas Car Park (56 spaces)
10. CMWS Hall Kildare Parking (19 spaces)
11. Station Road Parking (11 spaces)
12. Bridge Street (17 spaces)
13. Bangup Lane (4 spaces)

Draft

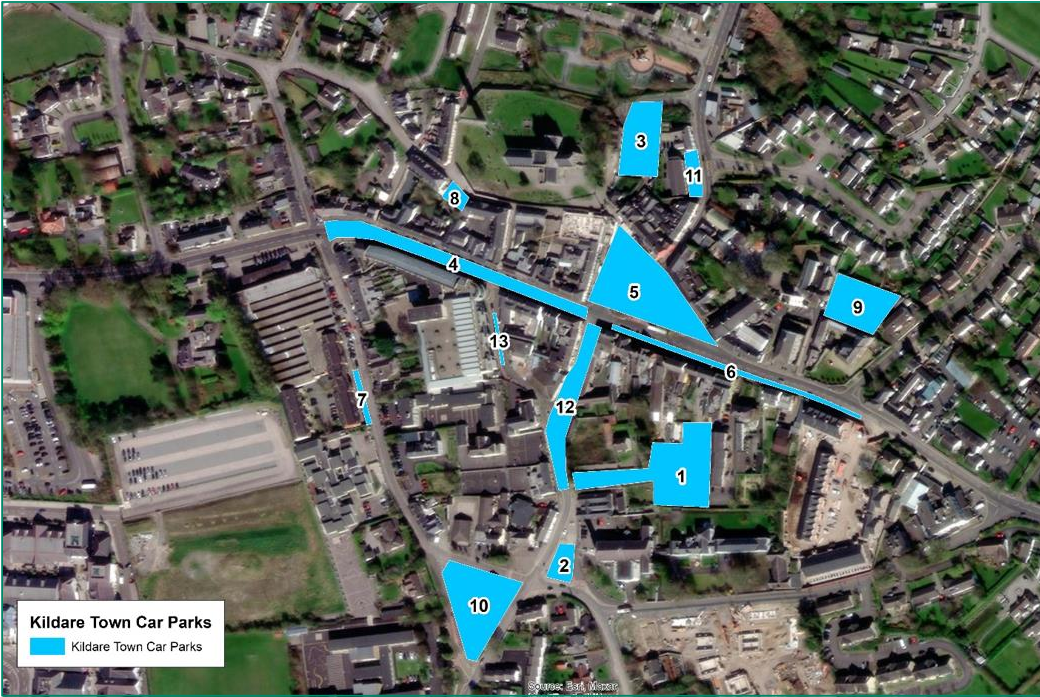

Figure 1.1 – Kildare Town Centre – Car Parking (Source: Google Maps)

It should be noted that the number of car parking spaces on Market Square has been reduced since 2020 with a temporary pedestrian public realm scheme in place. Currently the layout of Market square accommodates an enlarged public space to better accommodate outdoor activity in Kildare which has been illustrated in Figure 1.2.

As part of this Part 8, it is proposed to regularise the current arrangement on Market Square and also to reduce the number of parking spaces on Market Square East and on the south side of Main St. Previously there were approximately 38 No. parking spaces west of Bride Street which will now be removed. A further 10 No. spaces on South Main St. and 7 No. spaces on Market Square East will also be removed as part of this scheme.

6 No. parking spaces (incl 2 No. accessible) will be reintroduced in the Market Square as part of the application. The previous arrangement has been illustrated in Figure 1.3.



Figure 1.2 – Market Square Temporary Measures

Draft

Transmittal

Kildare Town Centre – Parking Kildare Town Centre – Parking Technical Note



Figure 1.3 – Market Square Car Park Arrangement (Source: Google Streetview, May 2019)

2. Initial Study Observations

From the review of the parking surveys, the peak parking demand periods were observed as follows:

- Friday 21st January - 14:30 – 15:30 with 303 parking spaces occupied (86% Max Occupancy);
- Saturday 22nd January - 14:00 – 14:30 with 260 parking spaces occupied (74% Max Occupancy); and,
- Sunday 23rd January - 11:00 – 11:30 with 246 parking spaces occupied (70% Max Occupancy).

The overall occupancy during the 30-minute intervals have been presented in Figure 2.1 to Figure 2.3 for the surveyed days.

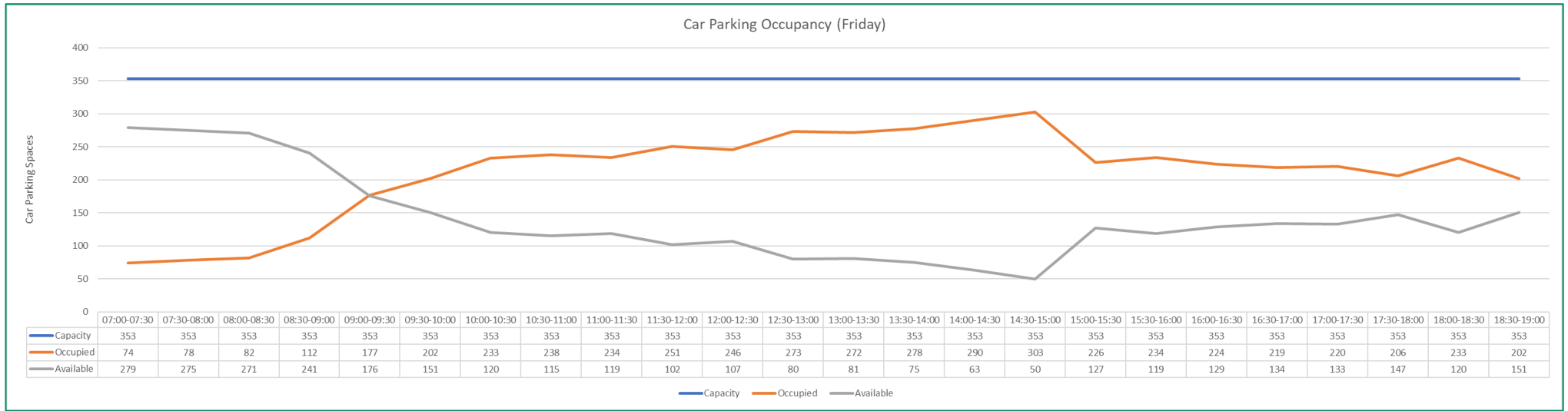

Figure 2.1 – Car Parking Occupancy (Friday)

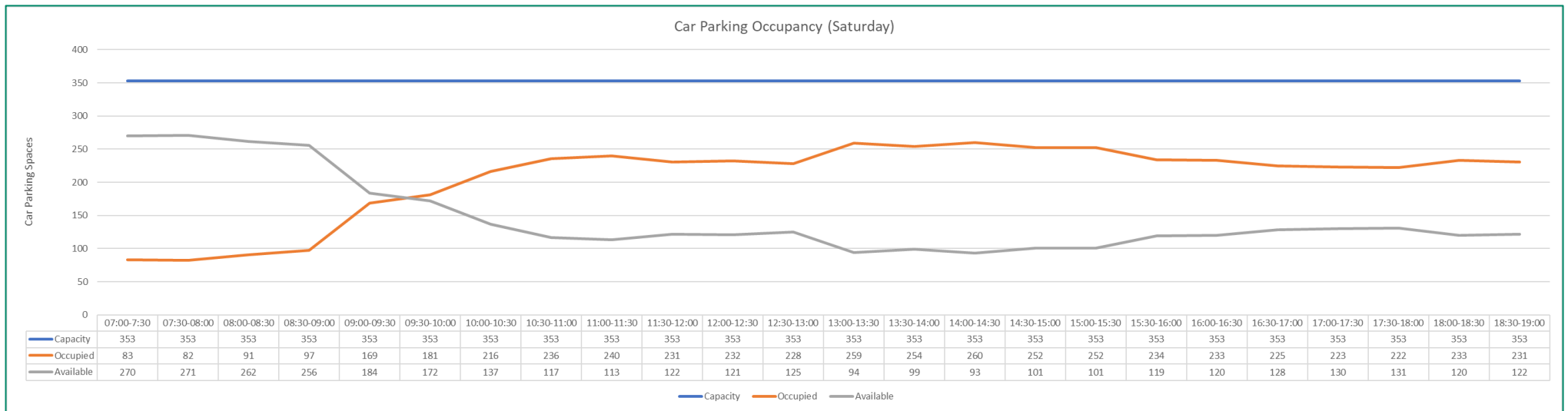

Figure 2.2 – Car Parking Occupancy (Saturday)

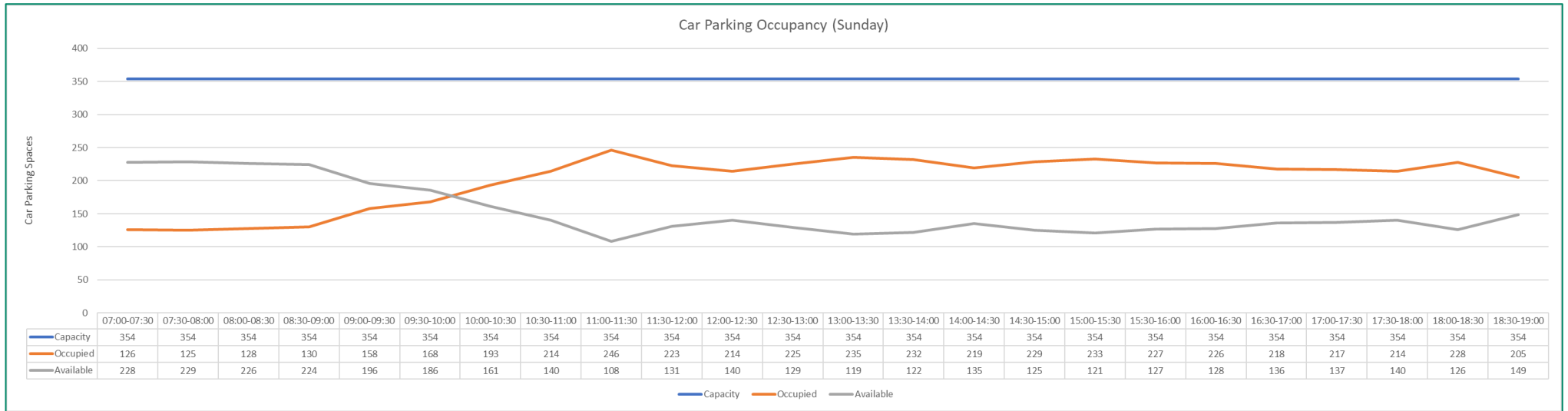

Figure 2.3 – Car Parking Occupancy (Sunday)

Draft

Transmittal
Kildare Town Centre – Parking Kildare Town Centre – Parking Technical Note

AECOM have interrogated the results and the following graphs (Figure 2.4 to Figure 2.6) show the observed car parking occupancy during the peak hour at each of the car parks, note that car parks which show a value in excess of 100% were observed to have had parking in non-designated locations (i.e. illegally parked).

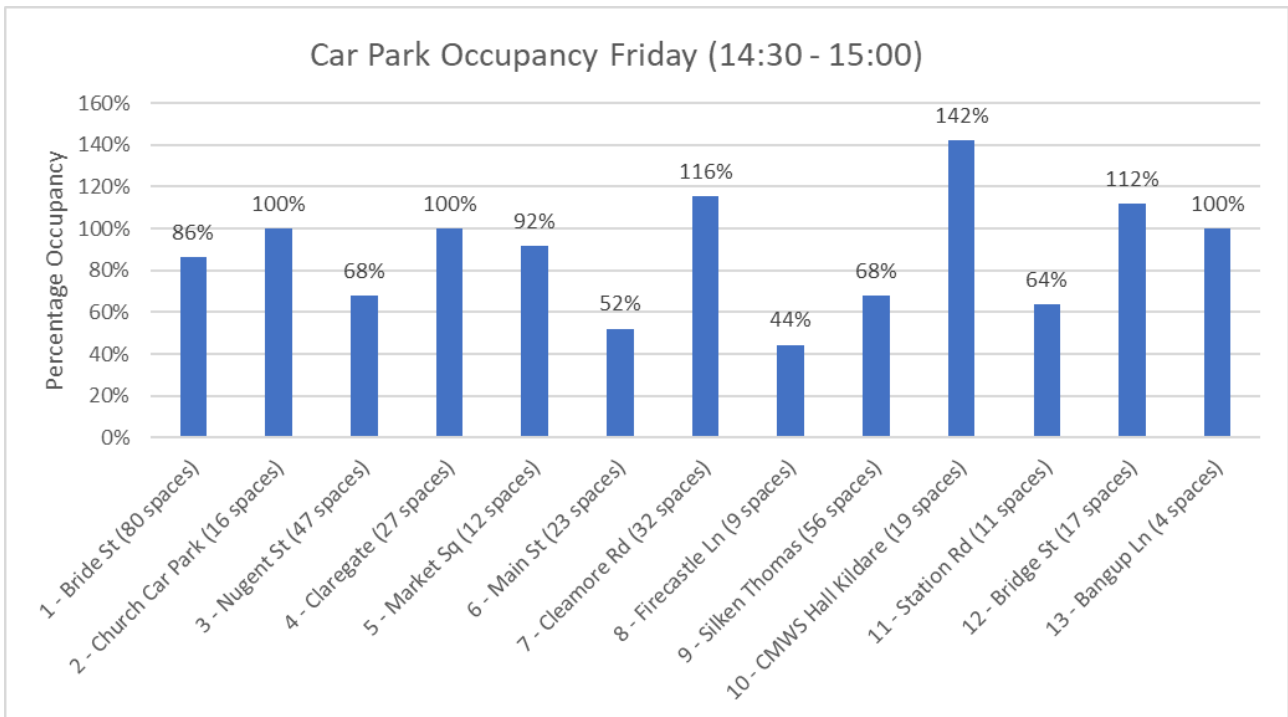

Figure 2.4 – Peak Car Park Occupancy Friday

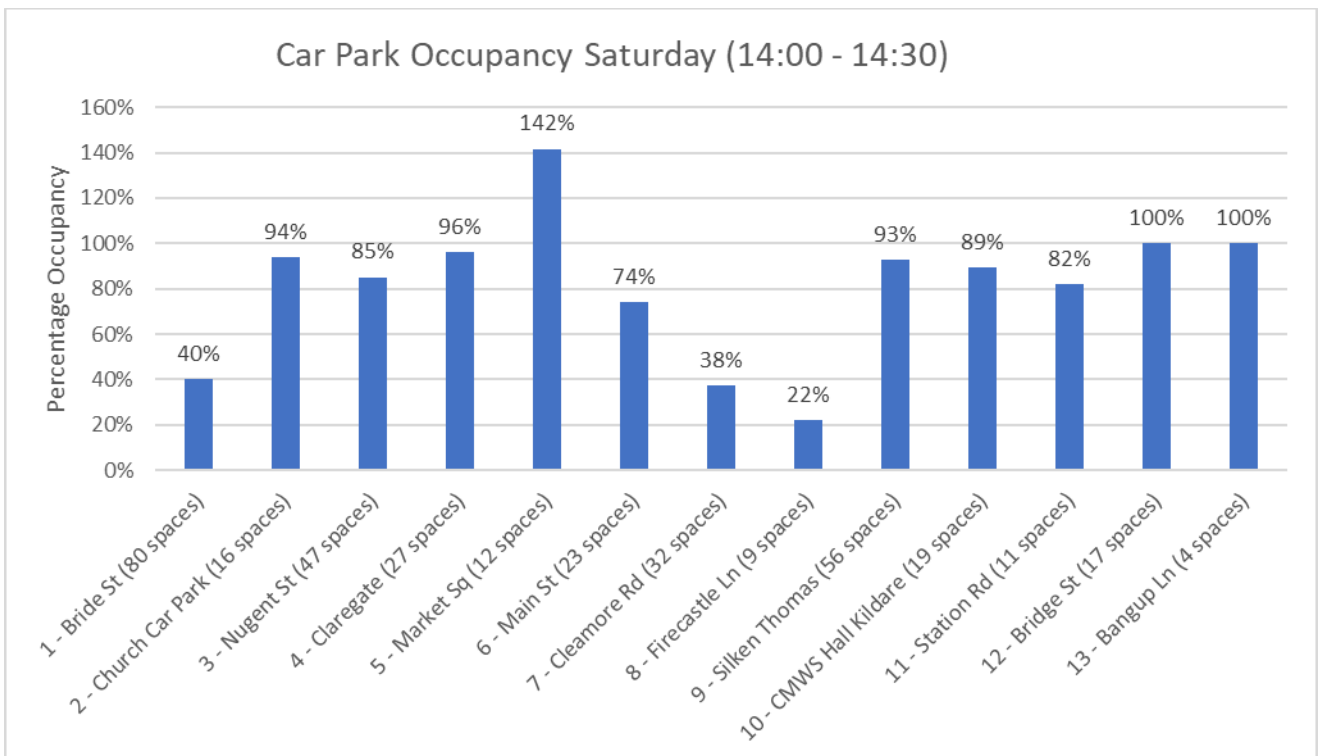

Figure 2.5 – Car Park Occupancy Saturday

Draft

Transmittal
Kildare Town Centre – Parking Kildare Town Centre – Parking Technical Note

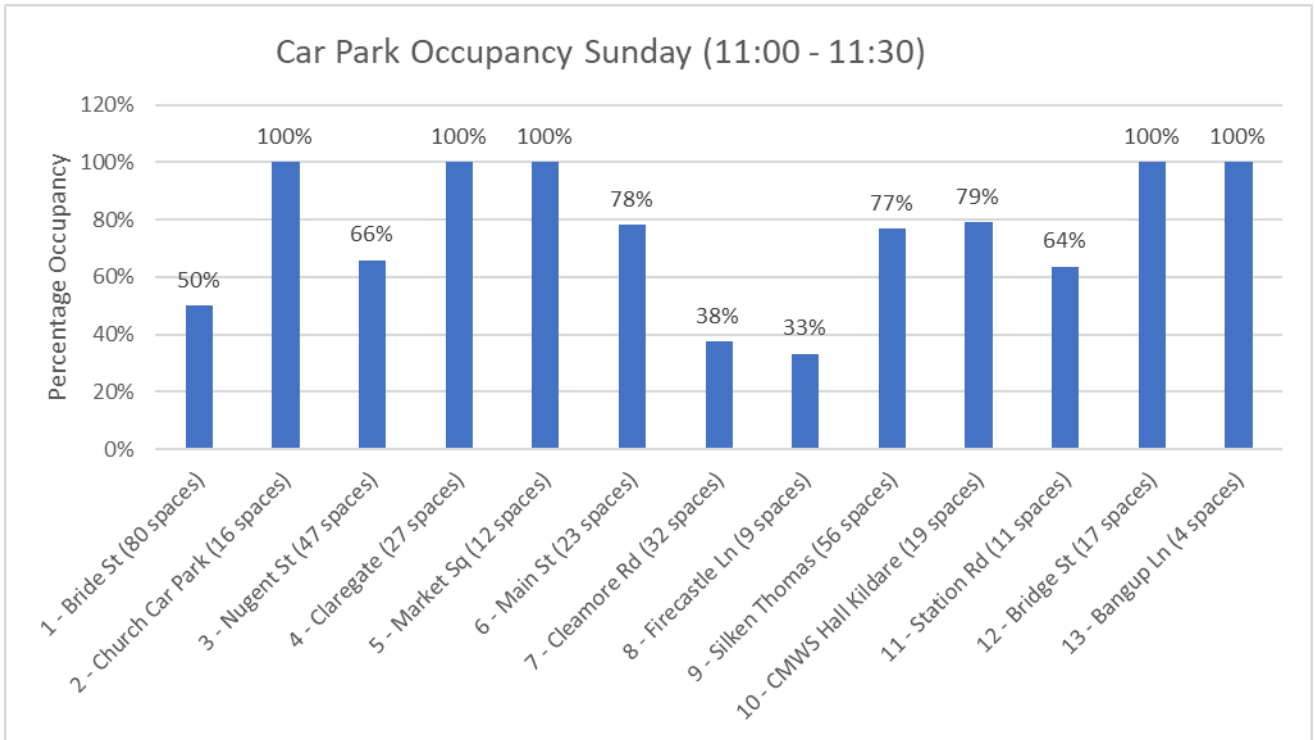
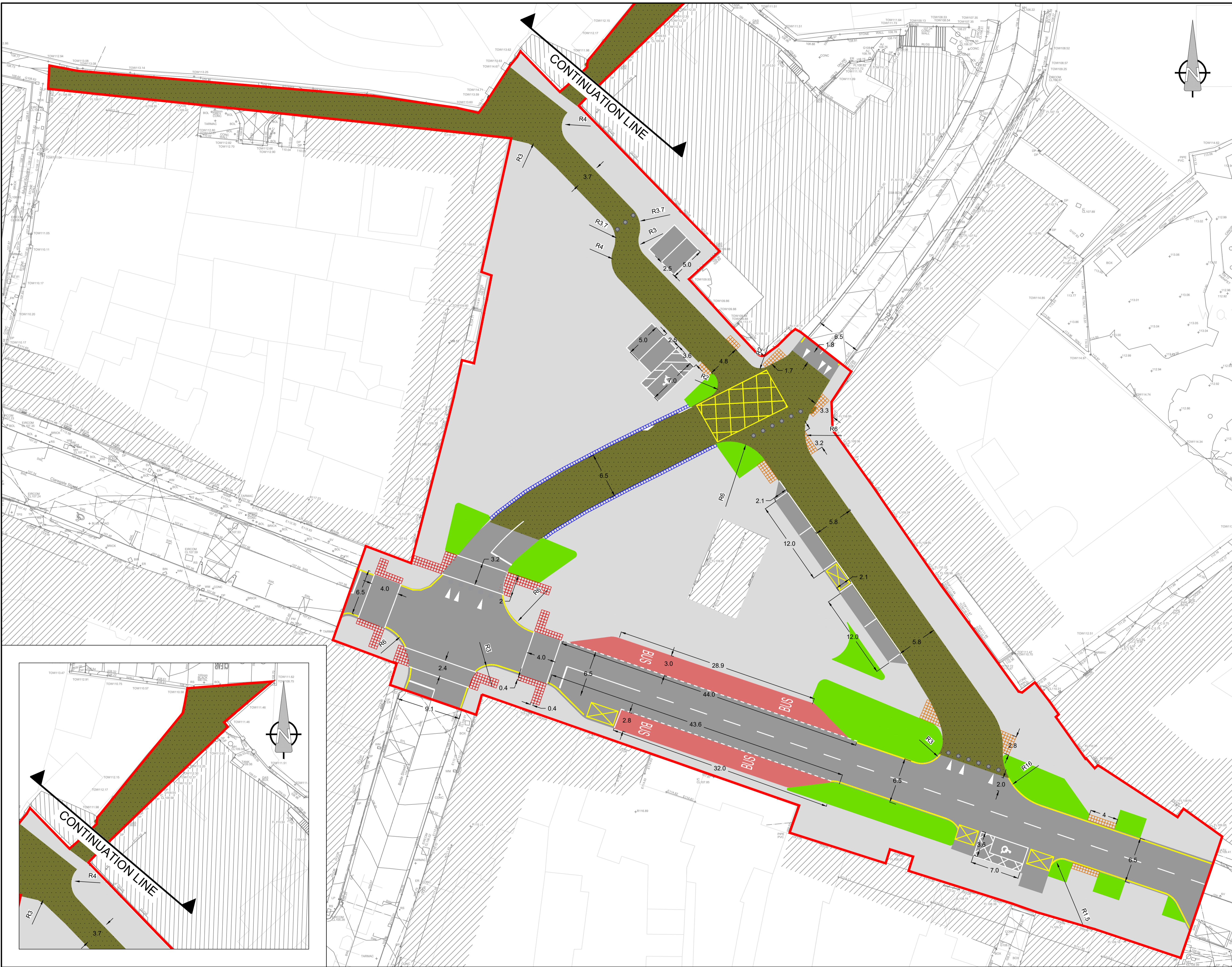

Figure 2.6 – Car Park Occupancy Sunday

Appendix E DMURS Compliance



PROJECT
 KILDARE MARKET SQUARE,
 CO.KILDARE

CLIENT
 KILDARE COUNTY COUNCIL

CONSULTANT
 AECOM
 4th Floor Adelphi Plaza,
 George's Street Upper,
 Dun Laoghaire,
 Co Dublin
 Tel: +353 (0)1 6966220
 www.aecom.com

- NOTES**
1. THIS DRAWING IS TO BE READ IN CONJUNCTION WITH ALL OTHER RELEVANT ARCHITECTURAL AND ENGINEERING DRAWINGS. ANY DISCREPANCIES, ERRORS OR OMISSIONS TO BE BROUGHT TO THE ATTENTION OF THE DESIGNER.
 2. ALL DIMENSIONS TO BE CHECKED BY THE CONTRACTOR ON SITE PRIOR TO COMMENCEMENT OF WORKS.
 3. AECOM LIMITED TO BE INFORMED BY THE CONTRACTOR OF ANY DISCREPANCIES PRIOR TO THE COMMENCEMENT OF WORKS ON SITE.
 4. DIMENSIONS OF ALL BOUNDARIES AND ADJOINING ROADS TO BE CHECKED ON SITE PRIOR TO COMMENCEMENT OF WORKS.

- LEGEND**
- RED LINE BOUNDARY
 - CONTROLLED TACTILE PAVING
 - UNCONTROLLED TACTILE PAVING
 - WARNING TACTILE PAVING
 - ROAD HATCH
 - FOOTPATH/ PEDESTRIAN HATCH
 - BUS STOP HATCH
 - SHARED SURFACE HATCH
 - LANDSCAPING HATCH
 - ROAD MARKINGS
 - RETRACTABLE BOLLARDS
 - INDICATIVE CYCLE PARKING

AECOM
 FOR INFORMATION ONLY

ISSUE/REVISION

NO	DATE	DESCRIPTION
C	17.07.2023	RESPONSE TO METOWORKS
B	05.07.2023	ISSUED FOR INFORMATION
A	15.06.2023	ISSUED FOR INFORMATION
I/R	DATE	DESCRIPTION

PROJECT NUMBER
 60594179

SHEET TITLE
 ROAD MARKINGS & DIMENSIONS

SHEET NUMBER
 60594179-ACM-00-XX-SK-CE-10-0006

A ROAD MARKINGS & DIMENSIONS
 0006 Scale: 1:250

This drawing has been prepared for the use of AECOM's client. It may not be used, modified, reproduced or relied upon by third parties, except as agreed by AECOM or as required by law. AECOM accepts no responsibility, and denies any liability whatsoever, to any party that uses or relies on this drawing without AECOM's express written consent. Do not scale this document. All measurements must be obtained from the stated dimensions.

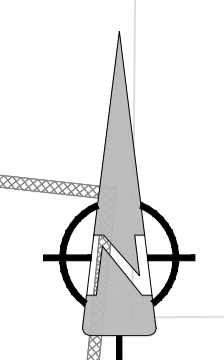

PROJECT
KILDARE MARKET SQUARE,
CO.KILDARE

CLIENT
KILDARE COUNTY COUNCIL

CONSULTANT
AECOM
4th Floor Adelphi Plaza,
George's Street Upper,
Dun Laoghaire,
Co Dublin
Tel:+353 (0)1 6966220
www.aecom.com

- NOTES**
1. THIS DRAWING IS TO BE READ IN CONJUNCTION WITH ALL OTHER RELEVANT ARCHITECTURAL AND ENGINEERING DRAWINGS. ANY DISCREPANCIES, ERRORS OR OMISSIONS TO BE BROUGHT TO THE ATTENTION OF THE DESIGNER.
 2. ALL DIMENSIONS TO BE CHECKED BY THE CONTRACTOR ON SITE PRIOR TO COMMENCEMENT OF WORKS.
 3. AECOM LIMITED TO BE INFORMED BY THE CONTRACTOR OF ANY DISCREPANCIES PRIOR TO THE COMMENCEMENT OF WORKS ON SITE.
 4. DIMENSIONS OF ALL BOUNDARIES AND ADJOINING ROADS TO BE CHECKED ON SITE PRIOR TO COMMENCEMENT OF WORKS.

- LEGEND**
- RED LINE BOUNDARY
 - CONTROLLED TACTILE PAVING
 - UNCONTROLLED TACTILE PAVING
 - WARNING TACTILE PAVING
 - ROAD HATCH
 - FOOTPATH/ PEDESTRIAN HATCH
 - BUS STOP HATCH
 - SHARED SURFACE HATCH
 - LANDSCAPING HATCH
 - ROAD MARKINGS
 - RETRACTABLE BOLLARDS
 - INDICATIVE CYCLE PARKING



ISSUE/REVISION

NO	DATE	DESCRIPTION
C	17.07.2023	RESPONSE TO METOWORKS
B	05.07.2023	ISSUED FOR INFORMATION
A	15.06.2023	ISSUED FOR INFORMATION
I/R	DATE	DESCRIPTION

PROJECT NUMBER
60594179

SHEET TITLE
GENERAL ARRANGMENT

SHEET NUMBER
60594179-ACM-00-XX-SK-CE-10-0100



A ROAD MARKINGS & DIMENSIONS
0006 Scale: 1:250

This drawing has been prepared for the use of AECOM's client. It may not be used, modified, reproduced or relied upon by third parties, except as agreed by AECOM or as required by law. AECOM accepts no responsibility, and denies any liability, whatsoever, to any party that uses or relies on this drawing without AECOM's express written consent. Do not scale this document. All measurements must be obtained from the stated dimensions.

Appendix F Swept Path Analysis

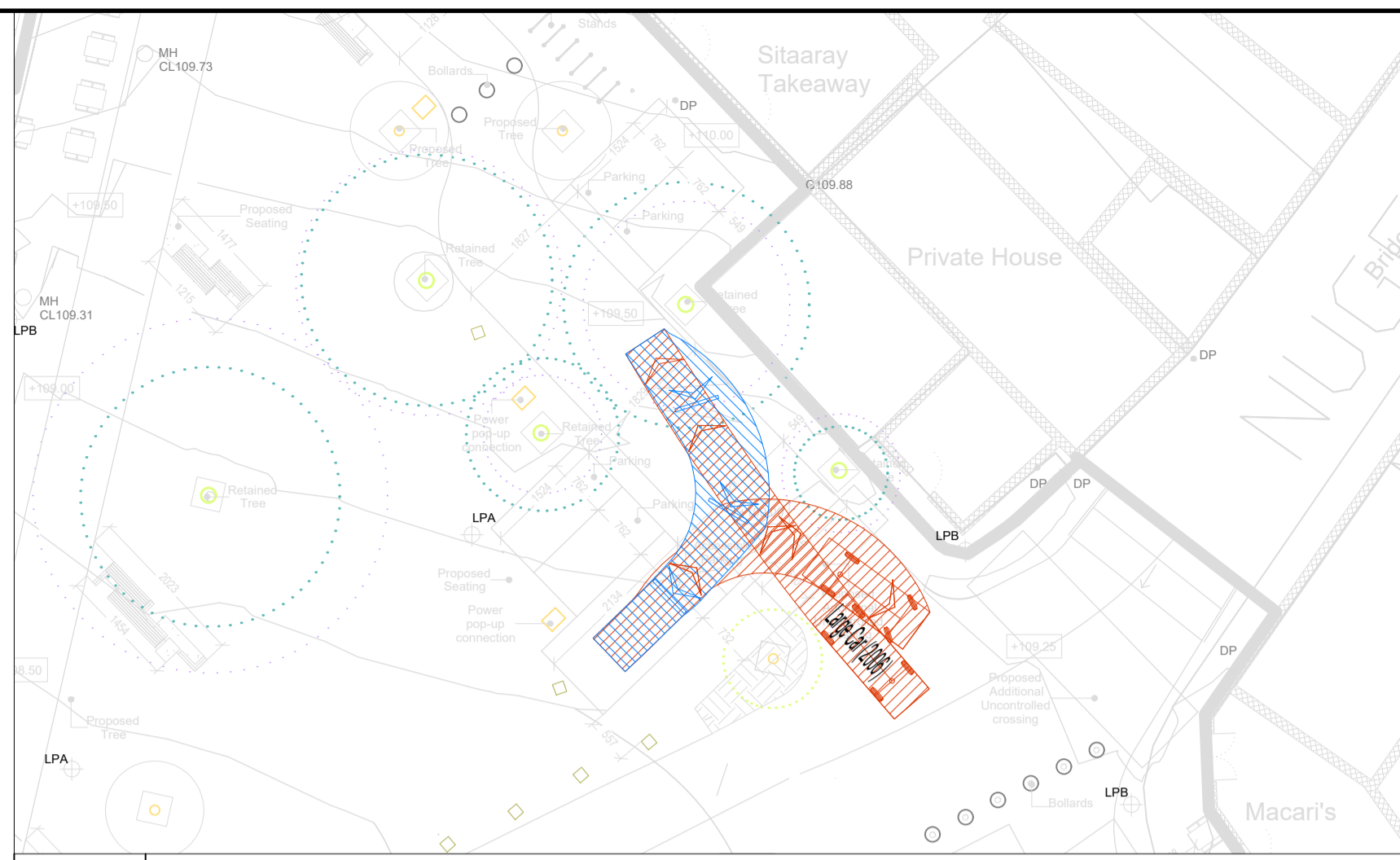
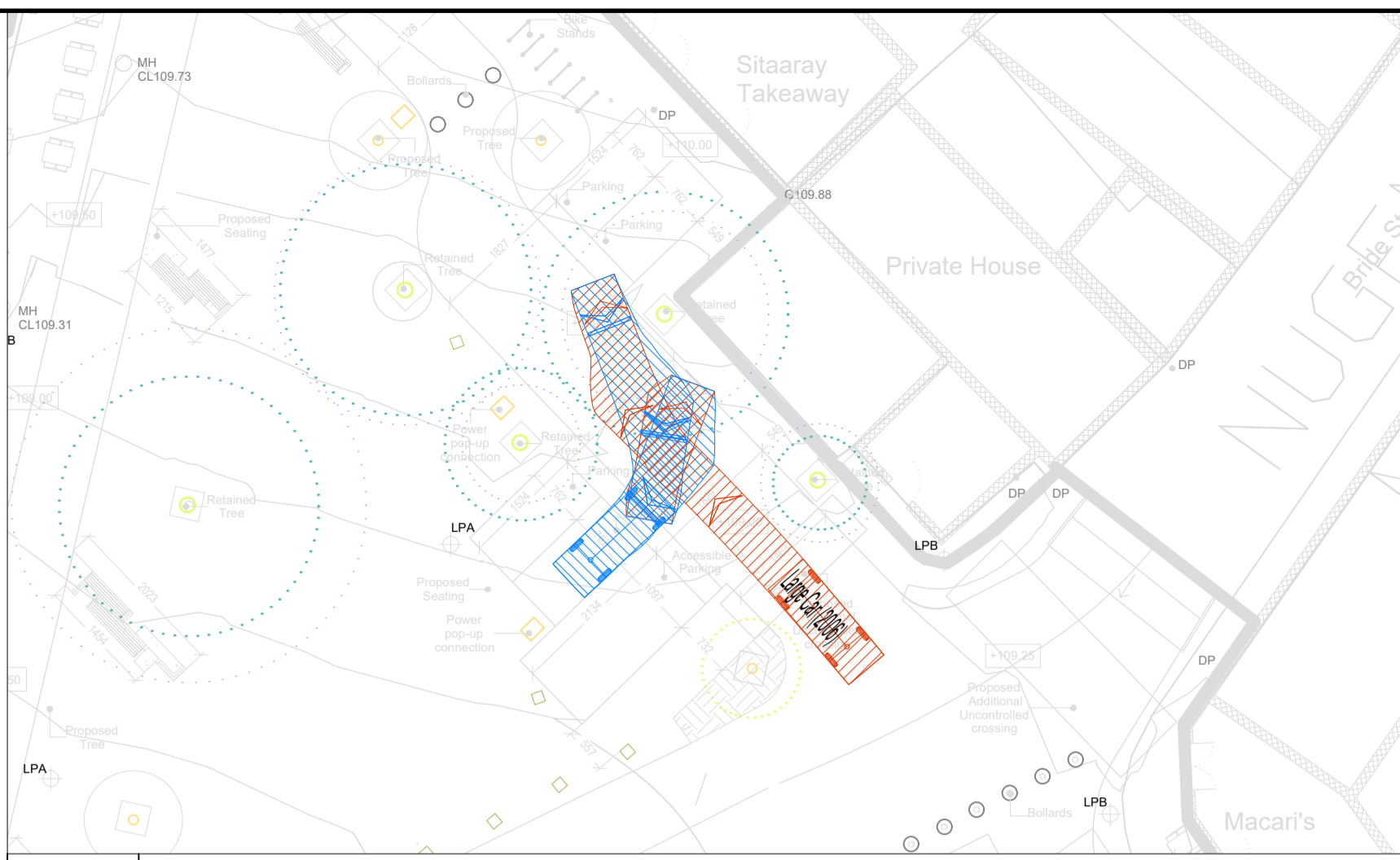
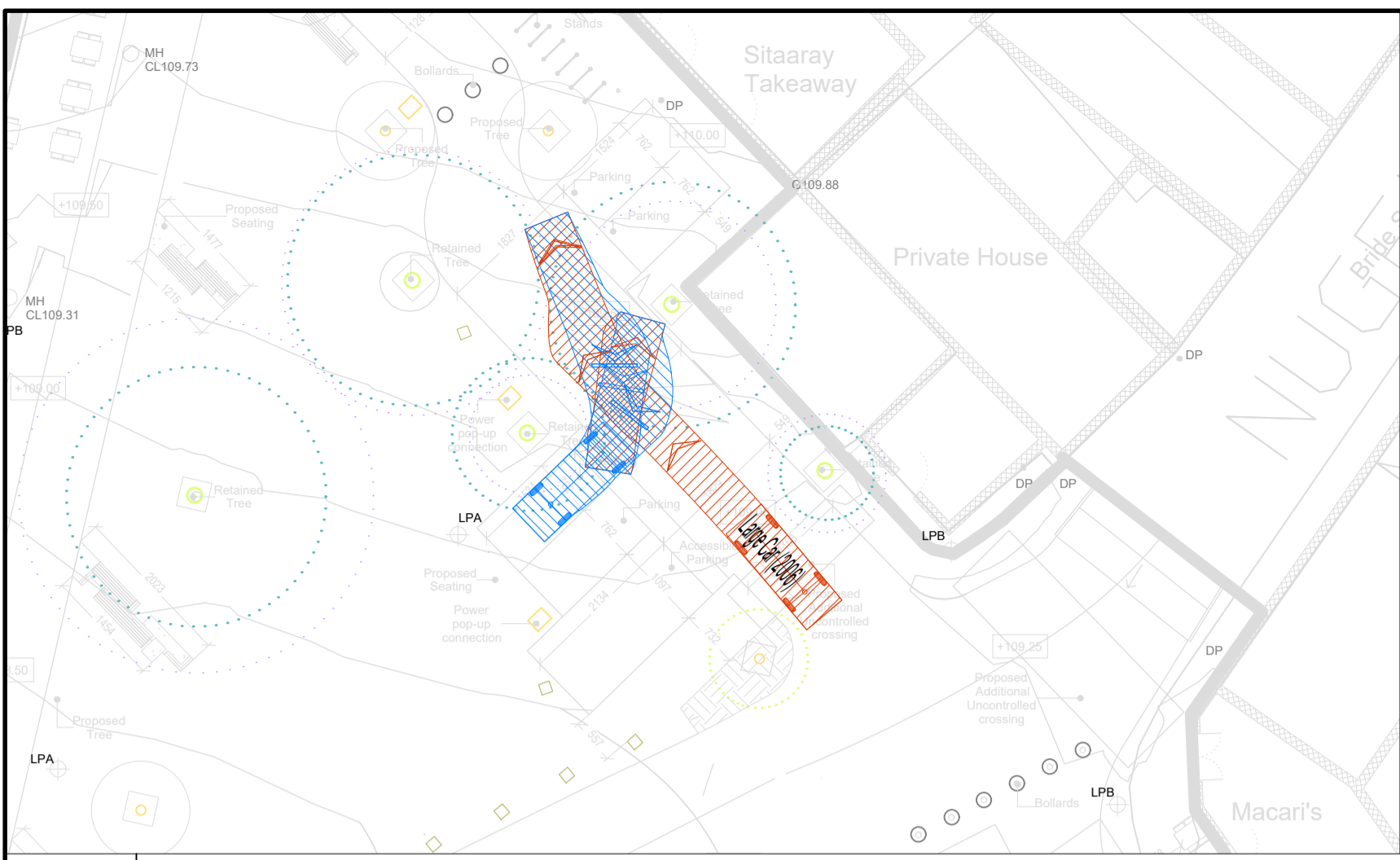

B AUTOTRACK ANALYSIS OF PROPOSED PARKING BAYS
 0001 Scale: 1:250

C AUTOTRACK ANALYSIS OF PROPOSED PARKING BAYS
 0001 Scale: 1:250

D AUTOTRACK ANALYSIS OF PROPOSED PARKING BAYS
 0001 Scale: 1:250

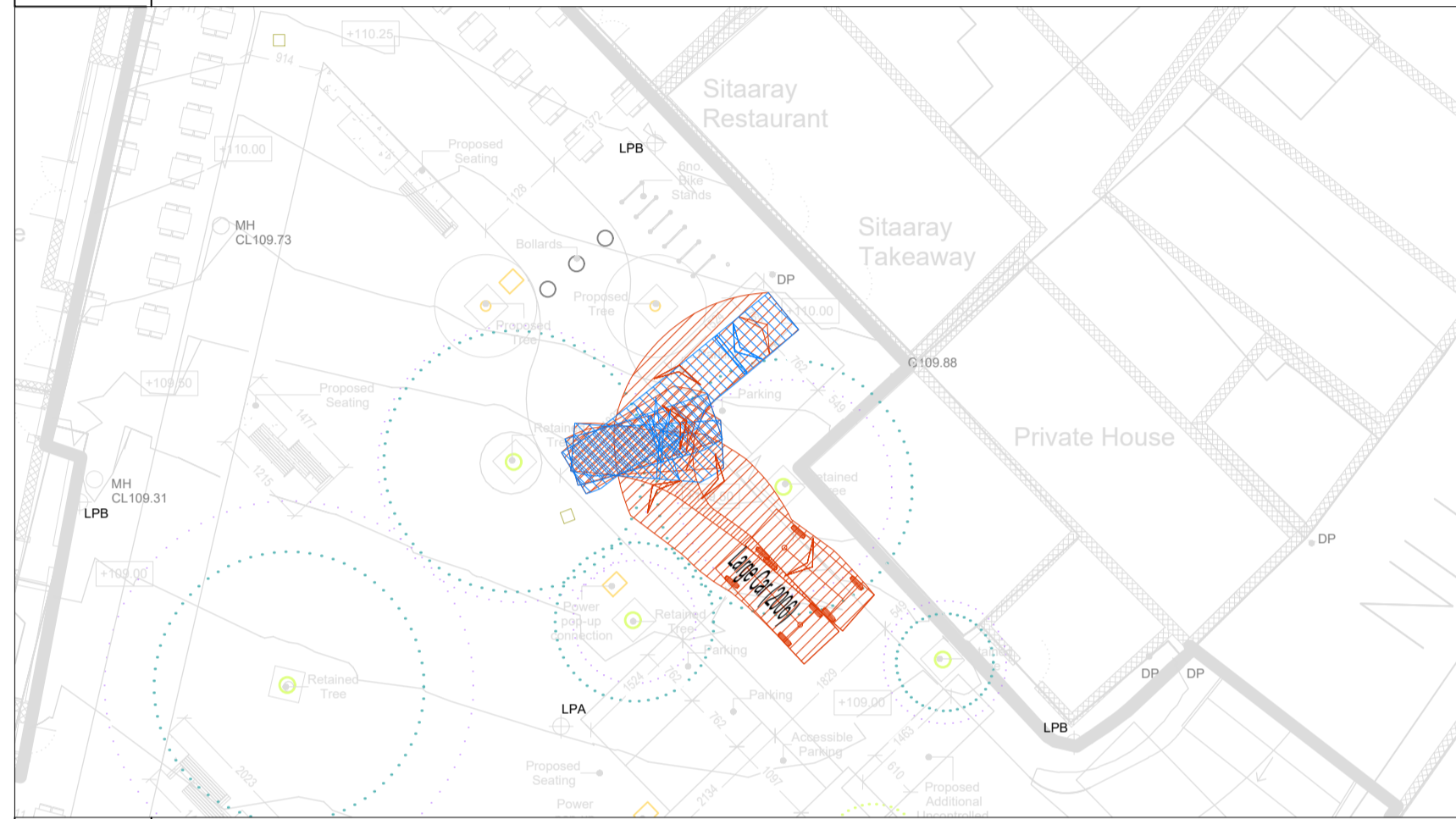
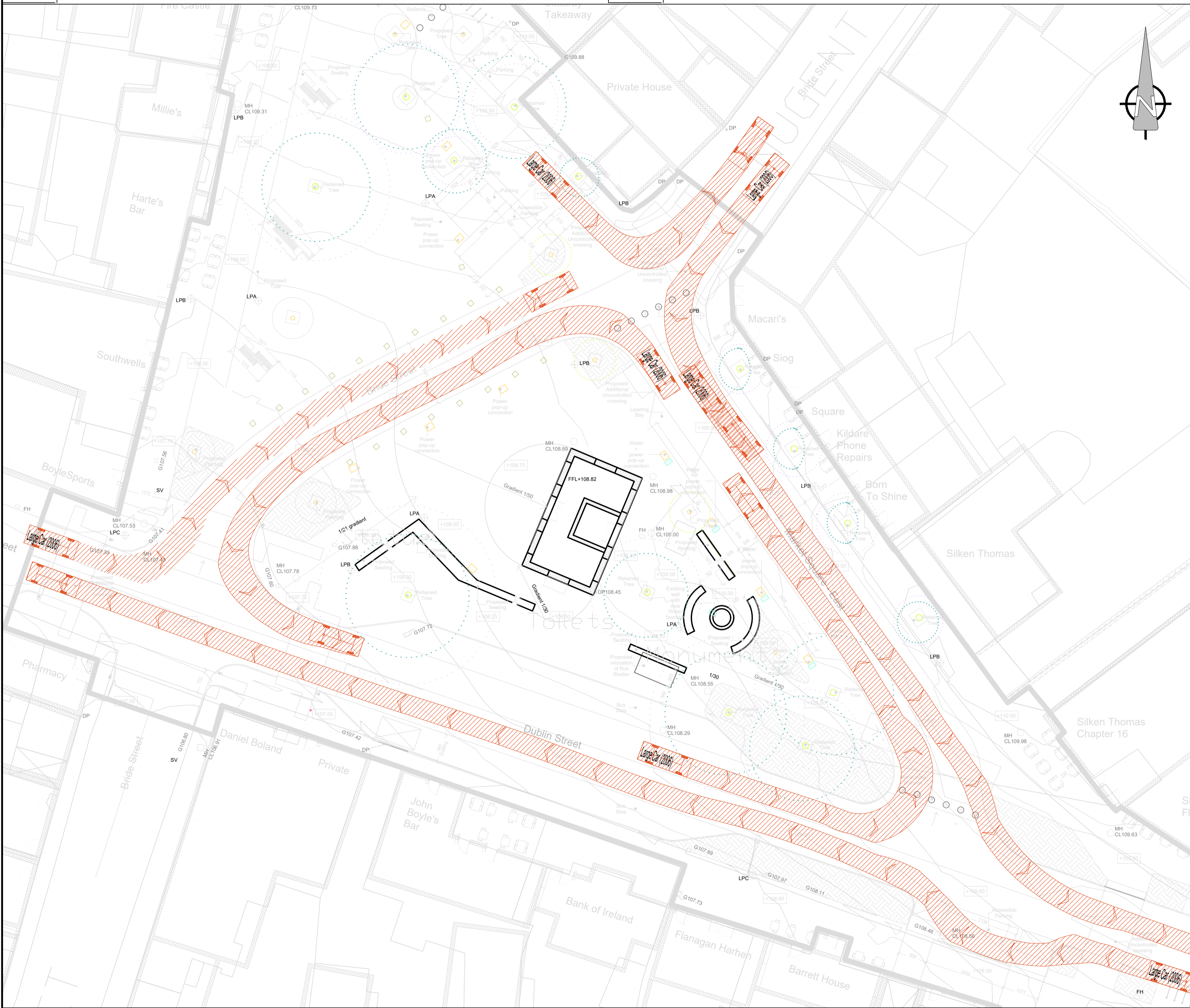

E AUTOTRACK ANALYSIS OF PROPOSED PARKING BAYS
 0001 Scale: 1:250

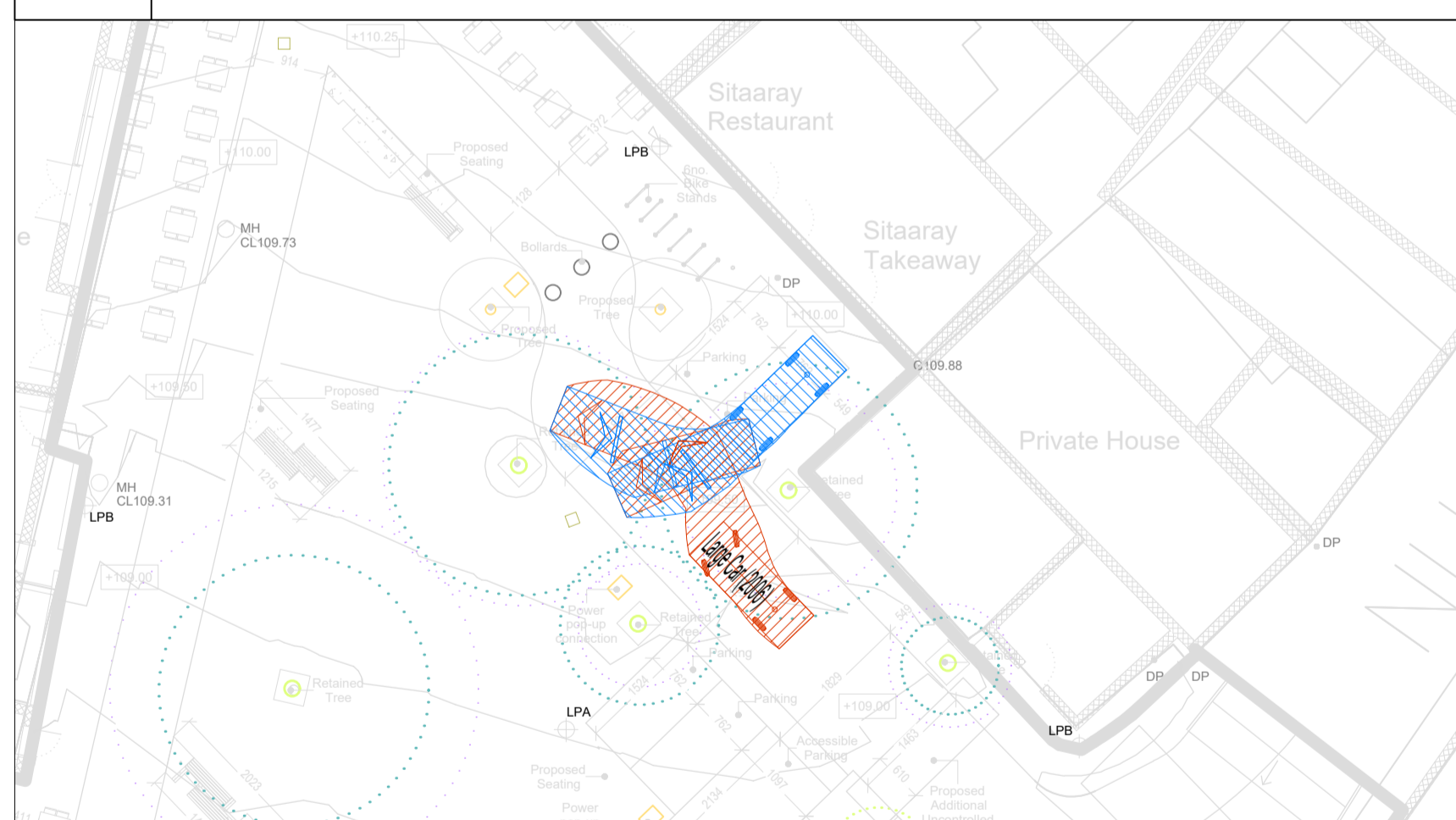

F AUTOTRACK ANALYSIS OF PROPOSED PARKING BAYS
 0001 Scale: 1:250

A PROPOSED SWEEP PATH ANALYSIS WITH LARGE CAR
 0001 Scale: 1:250

Street Furniture	
Public Bin	Fire Hydrant
Removable Bollard	ESR Box
Fixed Bollard	ER
Bollard Socket	ERCOM
Traffic Lights	TCB
Parking Meters	MH
Armstrong Junction	MH
Air Valve	G
	Gully
	IC
	CATV

AECOM

PROJECT
 KILDARE MARKET SQUARE,
 CO.KILDARE

CLIENT
 KILDARE COUNTY COUNCIL

CONSULTANT
 AECOM
 4th Floor Adelphi Plaza,
 George's Street Upper,
 Dun Laoghaire,
 Co Dublin
 Tel:+353 (0)1 6966220
 www.aecom.com

- NOTES**
- THIS DRAWING IS TO BE READ IN CONJUNCTION WITH ALL OTHER RELEVANT ARCHITECTURAL AND ENGINEERING DRAWINGS. ANY DISCREPANCIES, ERRORS OR OMISSIONS TO BE BROUGHT TO THE ATTENTION OF THE DESIGNER.
 - ALL DIMENSIONS TO BE CHECKED BY THE CONTRACTOR ON SITE PRIOR TO COMMENCEMENT OF WORKS.
 - AECOM LIMITED TO BE INFORMED BY THE CONTRACTOR OF ANY DISCREPANCIES PRIOR TO THE COMMENCEMENT OF WORKS ON SITE.
 - DIMENSIONS OF ALL BOUNDARIES AND ADJOINING ROADS TO BE CHECKED ON SITE PRIOR TO COMMENCEMENT OF WORKS.

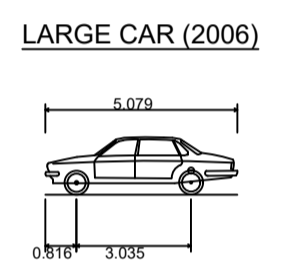

Overall Length	5.075m
Overall Width	1.872m
Overall Body Height	1.525m
Min Body Ground Clearance	0.310m
Max Track Width	1.931m
Lock to Lock Time	4.00 sec
Kerb to Kerb Turning Radius	5.900m

LEGEND:

	SWEEP PATH FORWARDS MOVEMENT
	SWEEP PATH REVERSE MOVEMENT



ISSUE/REVISION

NO.	DATE	DESCRIPTION
A	23.05.2023	ISSUED FOR INFORMATION
I/R	DATE	DESCRIPTION

PROJECT NUMBER
 60594179

SHEET TITLE
 PROPOSED SWEEP PATH ANALYSIS
 WITH LARGE CAR

SHEET NUMBER
 60594179-ACM-00-XX-SK-CE-10-0001

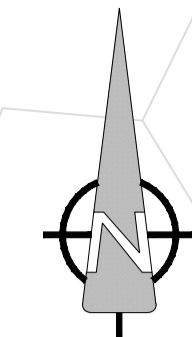

PROJECT
KILDARE MARKET SQUARE,
CO.KILDARE

CLIENT
KILDARE COUNTY COUNCIL

CONSULTANT
AECOM
4th Floor Adelphi Plaza,
George's Street Upper,
Dun Laoghaire,
Co Dublin
Tel:+353 (0)1 6966220
www.aecom.com

- NOTES**
- THIS DRAWING IS TO BE READ IN CONJUNCTION WITH ALL OTHER RELEVANT ARCHITECTURAL AND ENGINEERING DRAWINGS. ANY DISCREPANCIES, ERRORS OR OMISSIONS TO BE BROUGHT TO THE ATTENTION OF THE DESIGNER.
 - ALL DIMENSIONS TO BE CHECKED BY THE CONTRACTOR ON SITE PRIOR TO COMMENCEMENT OF WORKS.
 - AECOM LIMITED TO BE INFORMED BY THE CONTRACTOR OF ANY DISCREPANCIES PRIOR TO THE COMMENCEMENT OF WORKS ON SITE.
 - DIMENSIONS OF ALL BOUNDARIES AND ADJOINING ROADS TO BE CHECKED ON SITE PRIOR TO COMMENCEMENT OF WORKS.

Phoenix 2 Duo (P2-12W with Elite 6x4 chassis)

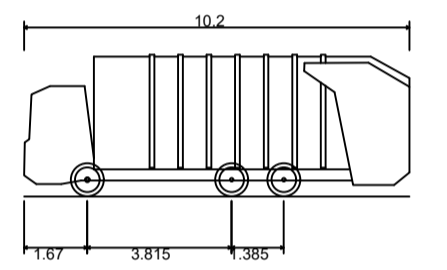

Overall Length	10.200m
Overall Width	2.530m
Overall Body Height	3.751m
Min Body Ground Clearance	0.304m
Track Width	2.500m
Lock to lock time	4.00s
Kerb to Kerb Turning Radius	7.800m

LEGEND:
 SWEEP PATH FORWARDS MOVEMENT



ISSUE/REVISION

NO	DATE	DESCRIPTION
A	23.05.2023	ISSUED FOR INFORMATION
I/R	DATE	DESCRIPTION

PROJECT NUMBER
60594179

SHEET TITLE
PROPOSED SWEEP PATH ANALYSIS
WITH LARGE REFUSE VEHICLE

SHEET NUMBER
60594179-ACM-00-XX-SK-CE-10-0002

This drawing has been prepared for the use of AECOM's client. It may not be used, modified, reproduced or relied upon by third parties, except as agreed by AECOM or as required by law. AECOM accepts no responsibility, and denies any liability whatsoever, to any party that uses or relies on this drawing without AECOM's express written consent. Do not scale this document. All measurements must be obtained from the stated dimensions.

ISO A1 594mm x 841mm
 Approved: JS
 Checked: HH
 Designer: KM
 Project Management Initials:
 Last saved by: GLEDDILLI (2023-11-20) Last Picked: 2023-11-30
 Filename: M:\OBS\PR-384133_KILDARE-NEWBRIDGE-TOWN\900_CAD_GIS\904_CE01_WIP\05_SKETCHES\2023.05.23_AUTOTRACKING_EXERCISE\60594179-ACM-XX-SK-CE-10-0001-0005_P02_1.DWG

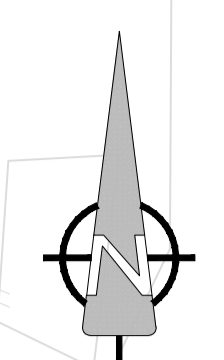

PROJECT
 KILDARE MARKET SQUARE,
 CO.KILDARE

CLIENT
 KILDARE COUNTY COUNCIL

CONSULTANT
 AECOM
 4th Floor Adelphi Plaza,
 George's Street Upper,
 Dun Laoghaire,
 Co Dublin
 Tel:+353 (0)1 6966220
 www.aecom.com

- NOTES**
- THIS DRAWING IS TO BE READ IN CONJUNCTION WITH ALL OTHER RELEVANT ARCHITECTURAL AND ENGINEERING DRAWINGS. ANY DISCREPANCIES, ERRORS OR OMISSIONS TO BE BROUGHT TO THE ATTENTION OF THE DESIGNER.
 - ALL DIMENSIONS TO BE CHECKED BY THE CONTRACTOR ON SITE PRIOR TO COMMENCEMENT OF WORKS.
 - AECOM LIMITED TO BE INFORMED BY THE CONTRACTOR OF ANY DISCREPANCIES PRIOR TO THE COMMENCEMENT OF WORKS ON SITE.
 - DIMENSIONS OF ALL BOUNDARIES AND ADJOINING ROADS TO BE CHECKED ON SITE PRIOR TO COMMENCEMENT OF WORKS.

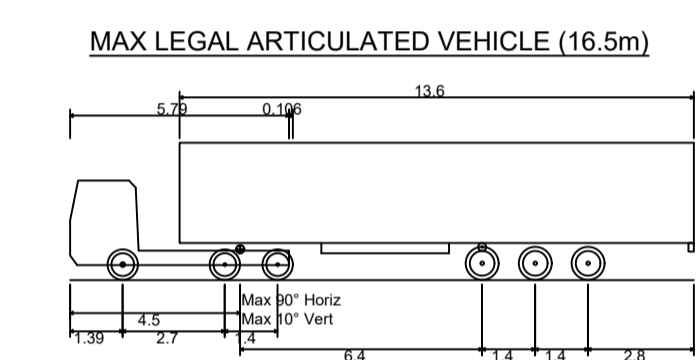

Overall Length	16.500m
Overall Width	2.500m
Overall Body Height	3.632m
Min Body Ground Clearance	0.396m
Max Track Width	2.500m
Lock to Lock Time	6.00 sec
Kerb to Kerb Turning Radius	6.870m

LEGEND:
 SWEEP PATH FORWARDS MOVEMENT



ISSUE/REVISION

NO	DATE	DESCRIPTION
A	23.05.2023	ISSUED FOR INFORMATION
I/R	DATE	DESCRIPTION

PROJECT NUMBER
 60594179

SHEET TITLE
 PROPOSED
 SWEEP PATH ANALYSIS
 WITH HGV SHEET 1 OF 2

SHEET NUMBER
 60594179-ACM-00-XX-SK-CE-10-0003

This drawing has been prepared for the use of AECOM's client. It may not be used, modified, reproduced or relied upon by third parties, except as agreed by AECOM or as required by law. AECOM accepts no responsibility, and denies any liability whatsoever, for any party that uses or relies on this drawing without AECOM's express written consent. Do not scale this document. All measurements must be obtained from the stated dimensions.

ISO A1 594mm x 841mm
 Approved: JS
 Checked: HH
 Designer: KM
 Project Management Initials:
 Last saved by: GLEDDILL (2023-11-20) Last Picked: 2023-11-30
 Filename: M:\OBS\PR-384133_KILDARE-NEWBRIDGE-TOWN\900_CAD_GIS\904_CE01_WIP\05_SKETCHES\2023.05.23_AUTOTRACKING_EXERCISE\60594179-ACM-XX-SK-CE-10-0001-0005_P02_1.DWG

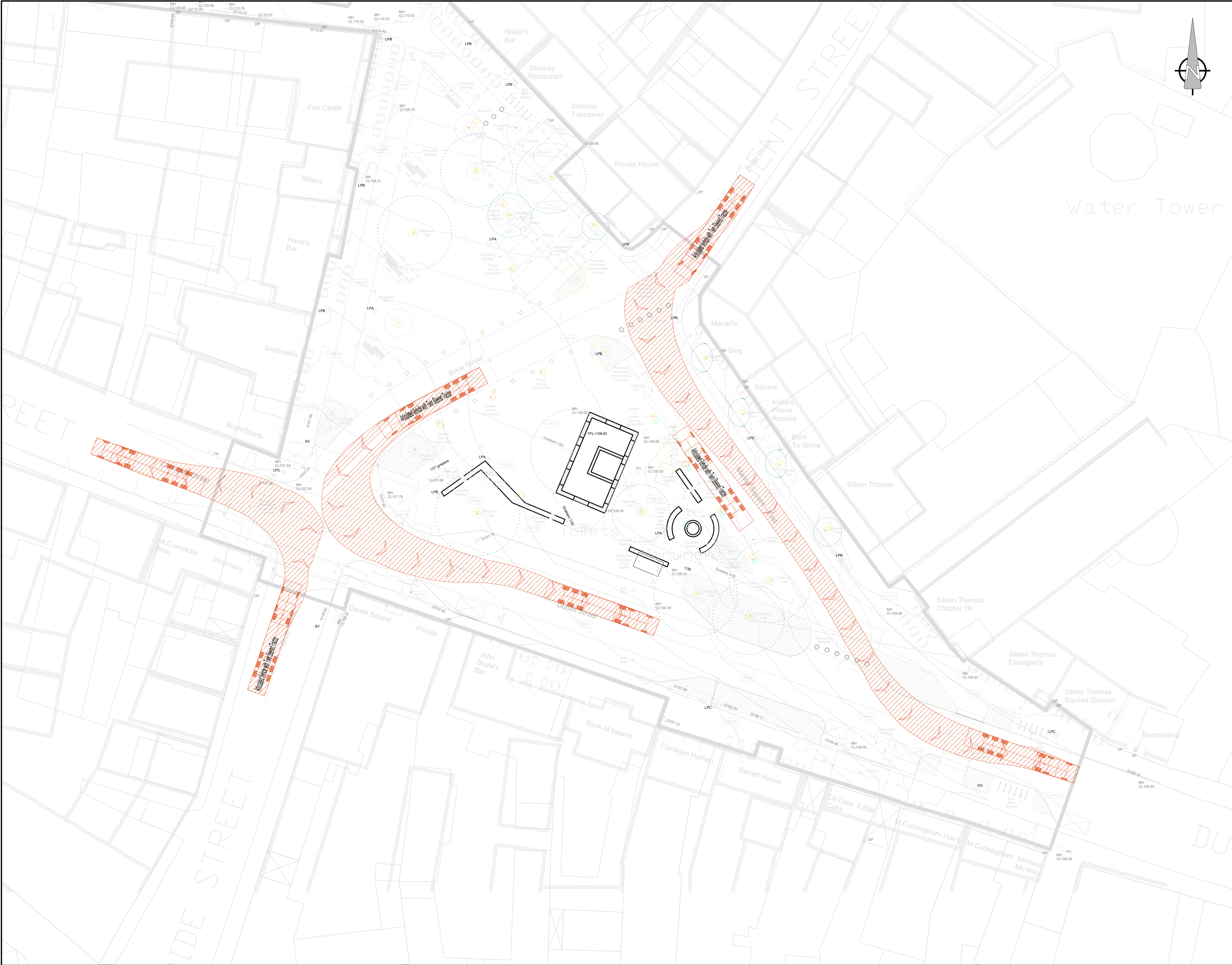

PROJECT
 KILDARE MARKET SQUARE,
 CO.KILDARE

CLIENT
 KILDARE COUNTY COUNCIL

CONSULTANT
 AECOM
 4th Floor Adelphi Plaza,
 George's Street Upper,
 Dun Laoghaire,
 Co Dublin
 Tel:+353 (0)1 6966220
 www.aecom.com

- NOTES**
- THIS DRAWING IS TO BE READ IN CONJUNCTION WITH ALL OTHER RELEVANT ARCHITECTURAL AND ENGINEERING DRAWINGS. ANY DISCREPANCIES, ERRORS OR OMISSIONS TO BE BROUGHT TO THE ATTENTION OF THE DESIGNER.
 - ALL DIMENSIONS TO BE CHECKED BY THE CONTRACTOR ON SITE PRIOR TO COMMENCEMENT OF WORKS.
 - AECOM LIMITED TO BE INFORMED BY THE CONTRACTOR OF ANY DISCREPANCIES PRIOR TO THE COMMENCEMENT OF WORKS ON SITE.
 - DIMENSIONS OF ALL BOUNDARIES AND ADJOINING ROADS TO BE CHECKED ON SITE PRIOR TO COMMENCEMENT OF WORKS.

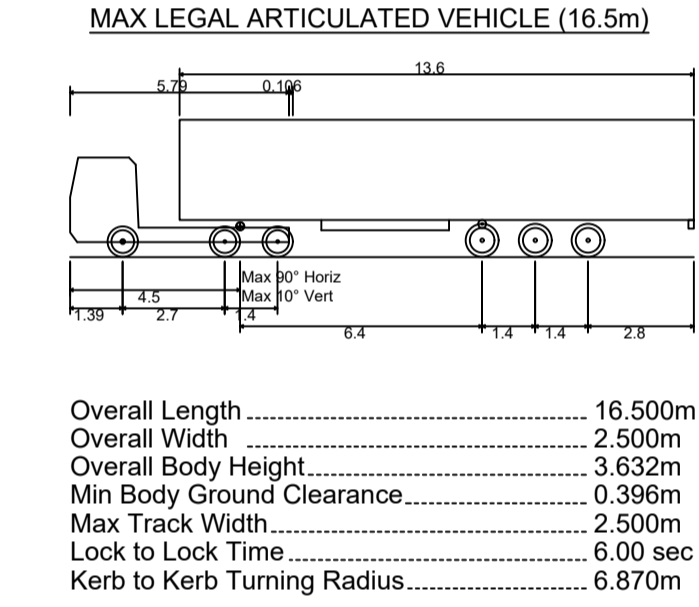

LEGEND:
 SWEEP PATH FORWARDS MOVEMENT



ISSUE/REVISION

NO	DATE	DESCRIPTION
A	23.05.2023	ISSUED FOR INFORMATION
I/R	DATE	DESCRIPTION

PROJECT NUMBER
 60594179

SHEET TITLE
 PROPOSED
 SWEEP PATH ANALYSIS
 WITH HGV SHEET 2 OF 2

SHEET NUMBER
 60594179-ACM-00-XX-SK-CE-10-0004

A PROPOSED SWEEP PATH ANALYSIS WITH HGV SHEET 2 OF 2
 0004 Scale: 1:250

ORDNANCE SURVEY IRELAND LICENCE NO CYAL50317588
 ©ORDNANCE SURVEY IRELAND / GOVERNMENT OF IRELAND

This drawing has been prepared for the use of AECOM's client. It may not be used, modified, reproduced or relied upon by third parties, except as required by law. AECOM accepts no responsibility, and denies any liability whatsoever, for any party that uses or relies on this drawing without AECOM's express written consent. Do not scale this document. All measurements must be obtained from the stated dimensions.

- NOTES**
- THIS DRAWING IS TO BE READ IN CONJUNCTION WITH ALL OTHER RELEVANT ARCHITECTURAL AND ENGINEERING DRAWINGS. ANY DISCREPANCIES, ERRORS OR OMISSIONS TO BE BROUGHT TO THE ATTENTION OF THE DESIGNER.
 - ALL DIMENSIONS TO BE CHECKED BY THE CONTRACTOR ON SITE PRIOR TO COMMENCEMENT OF WORKS.
 - AECOM LIMITED TO BE INFORMED BY THE CONTRACTOR OF ANY DISCREPANCIES PRIOR TO THE COMMENCEMENT OF WORKS ON SITE.
 - DIMENSIONS OF ALL BOUNDARIES AND ADJOINING ROADS TO BE CHECKED ON SITE PRIOR TO COMMENCEMENT OF WORKS.

LEGEND:
 SWEEP PATH FORWARDS MOVEMENT

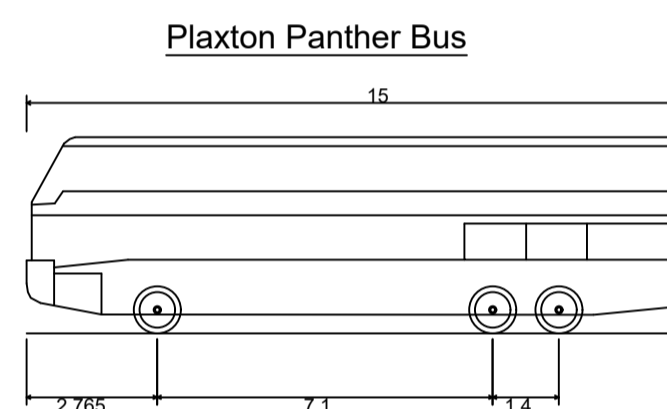

Overall Length	15.000m
Overall Width	2.500m
Overall Body Height	4.157m
Min Body Ground Clearance	0.397m
Track Width	2.500m
Lock to Lock Time	5.00s
Wall to Wall Turning Radius	12.500m

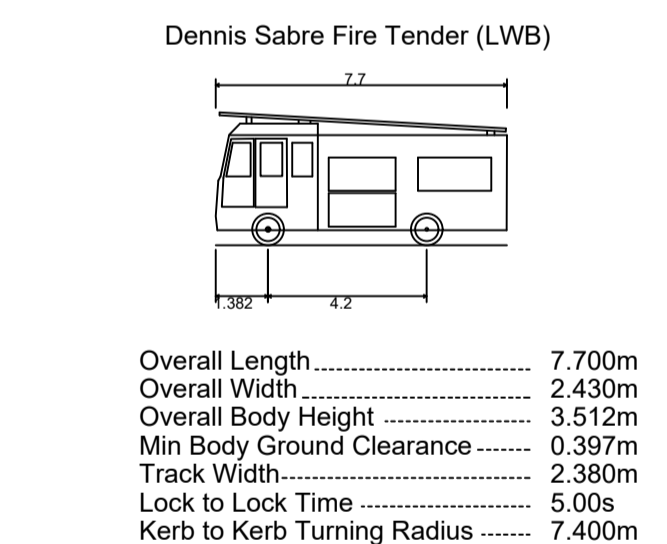

AECOM
FOR INFORMATION ONLY

ISSUE/REVISION

NO	DATE	DESCRIPTION
A	23.05.2023	ISSUED FOR INFORMATION
I/R	DATE	DESCRIPTION

PROJECT NUMBER
60594179

SHEET TITLE
PROPOSED SWEEP PATH ANALYSIS
WITH FIRE TENDER AND COACH

SHEET NUMBER
60594179-ACM-00-XX-SK-CE-10-0005

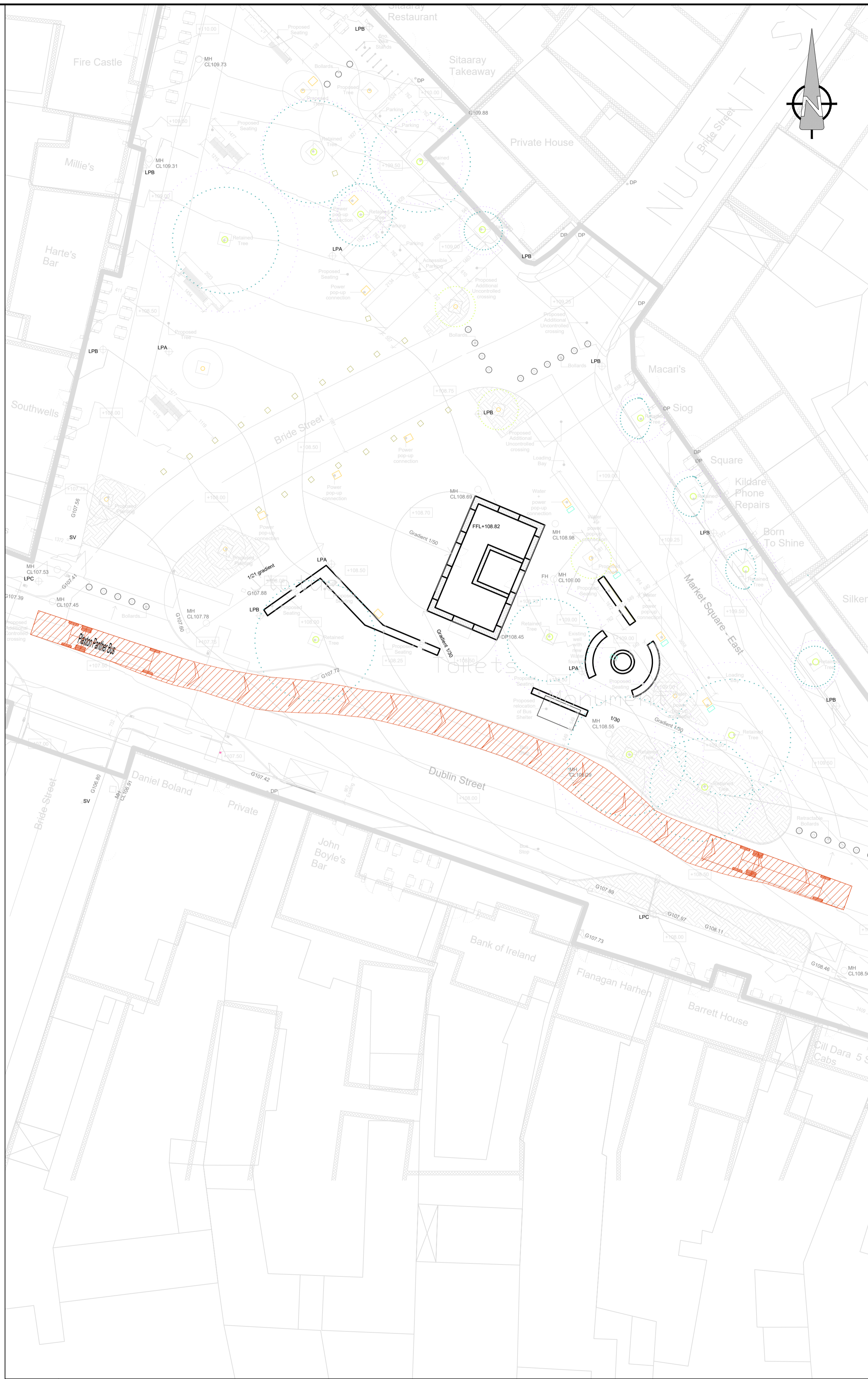

A PROPOSED SWEEP PATH ANALYSIS WITH FIRE TENDER
0005 Scale: 1:250

B PROPOSED SWEEP PATH ANALYSIS OF BUS LAYBY
0005 Scale: 1:250

Appendix G Flow Diagrams

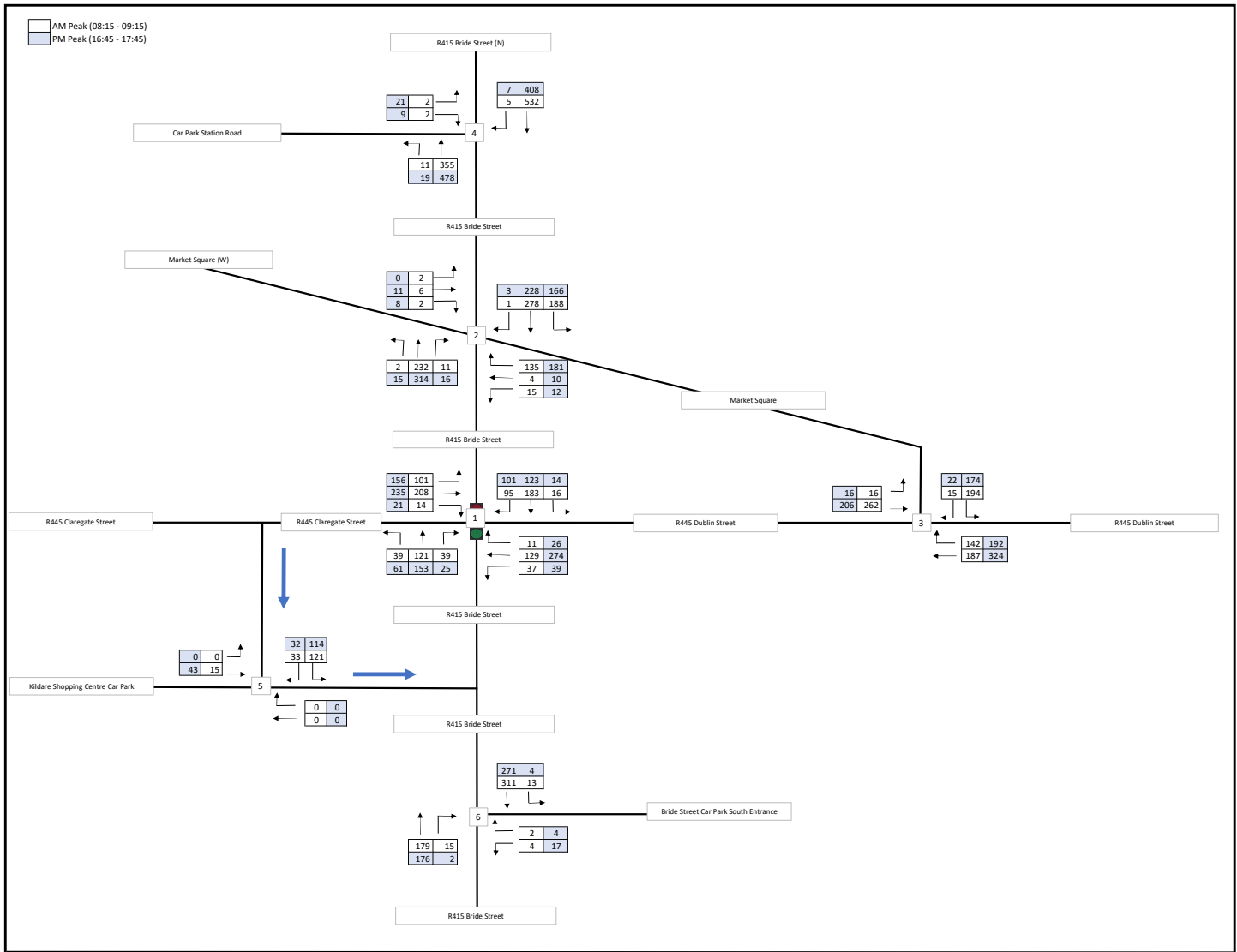

Client:	Kildare County Council	Title:	Friday 21.01.2022 Market Square Traffic Flows (PCUs)	Date:	02/10/2023	
Project:	Kildare Market Square	AECOM	Baseline Network Flow Diagram - AM and PM 2022	Design:	JS	
				Checked:	JS	
			Revision:	1	Approved:	JS

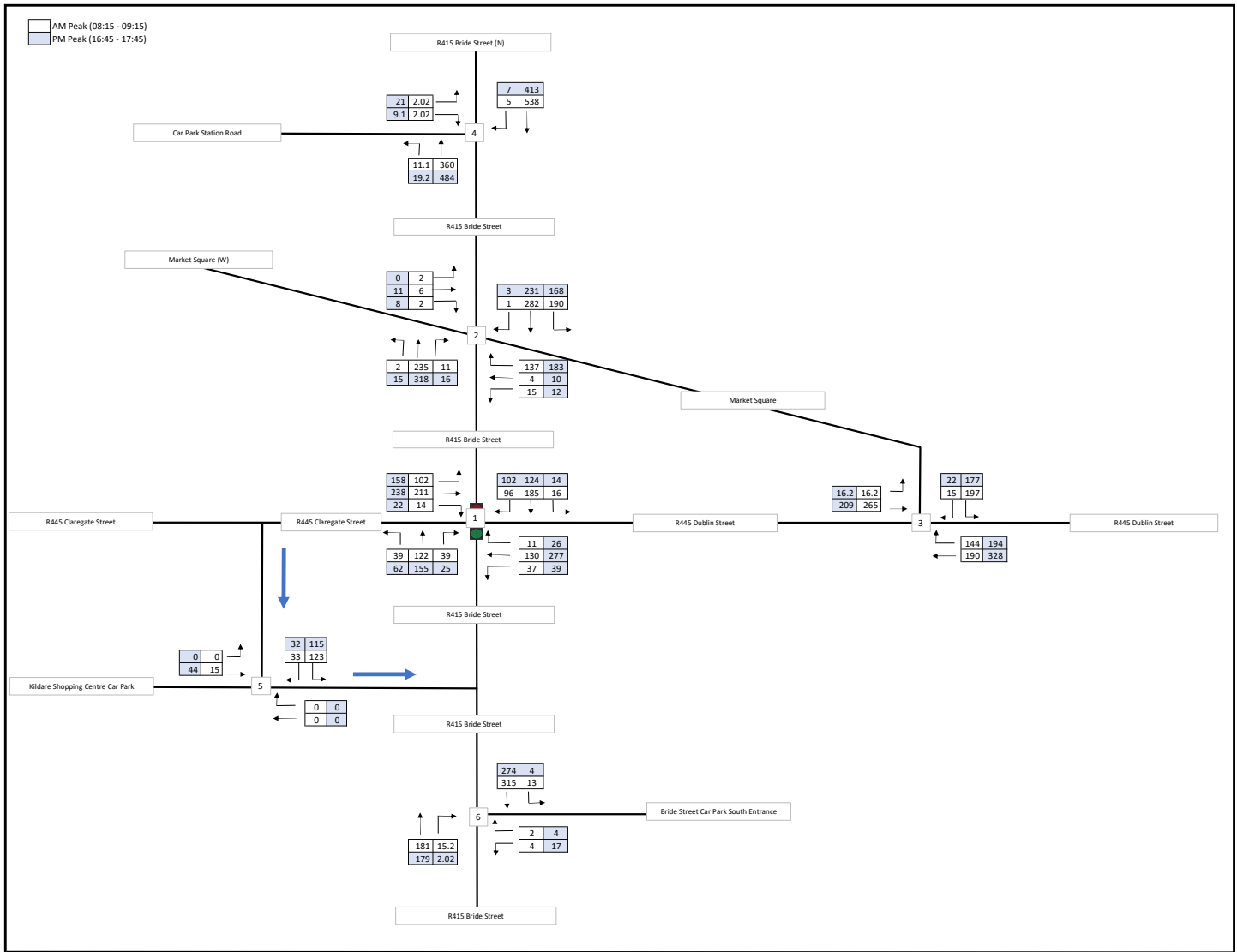

Client:	Kildare County Council	Title:	2024 AM and PM Flows (PCUs)		Date:	02/10/2023
Project:	Kildare Market Square	AECOM	Revision:	1	Checked:	JS
					Approved:	JS

Taken from LinSig Results

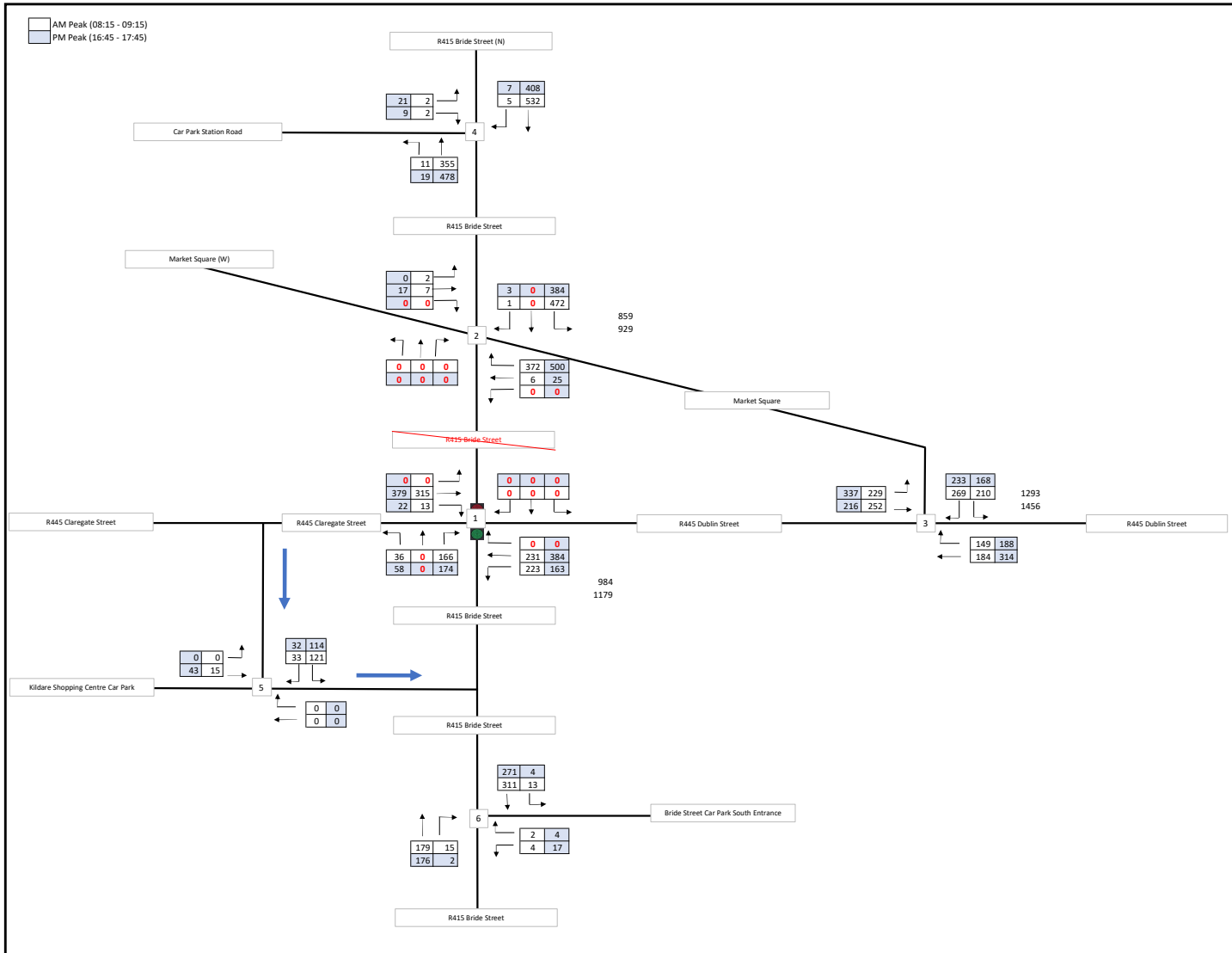

Client:	Kildare County Council	Title:	2024 AM and PM flows - Bride Street Closure (PCUs)	Date:	02/10/2023
Project:	Kildare Market Square	Revision:	1	Design:	JS
AECOM			Checked:	JS	
			Approved:	JS	

Taken from LinSig Results

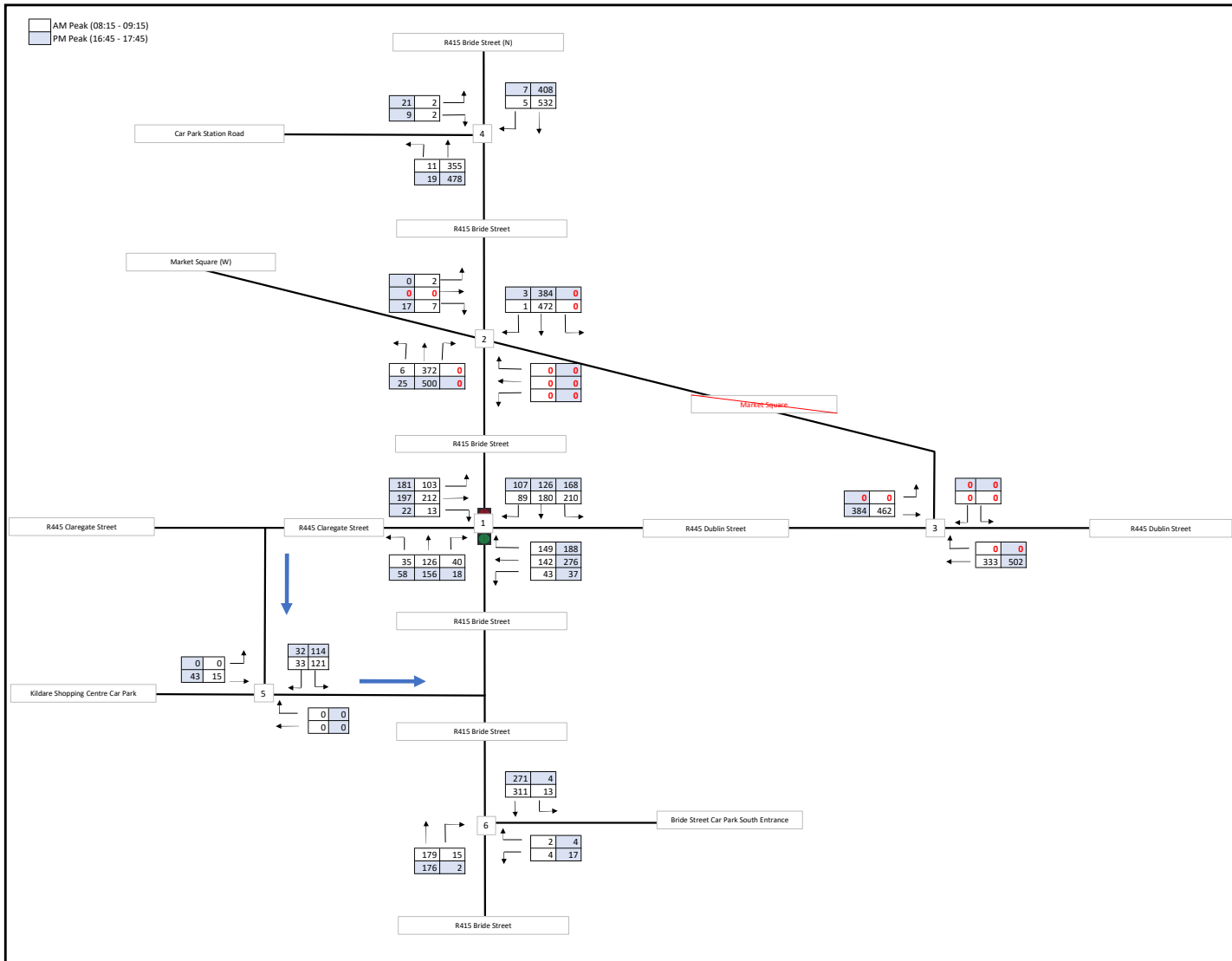

Client:	Kildare County Council	Title:	2024 AM and PM flows Market Square Closure (PCUs)	Date:	02/10/2023	
Project:	Kildare Market Square	AECOM	Revision:	1	Design:	JG
					Checked:	JS
					Approved:	JS

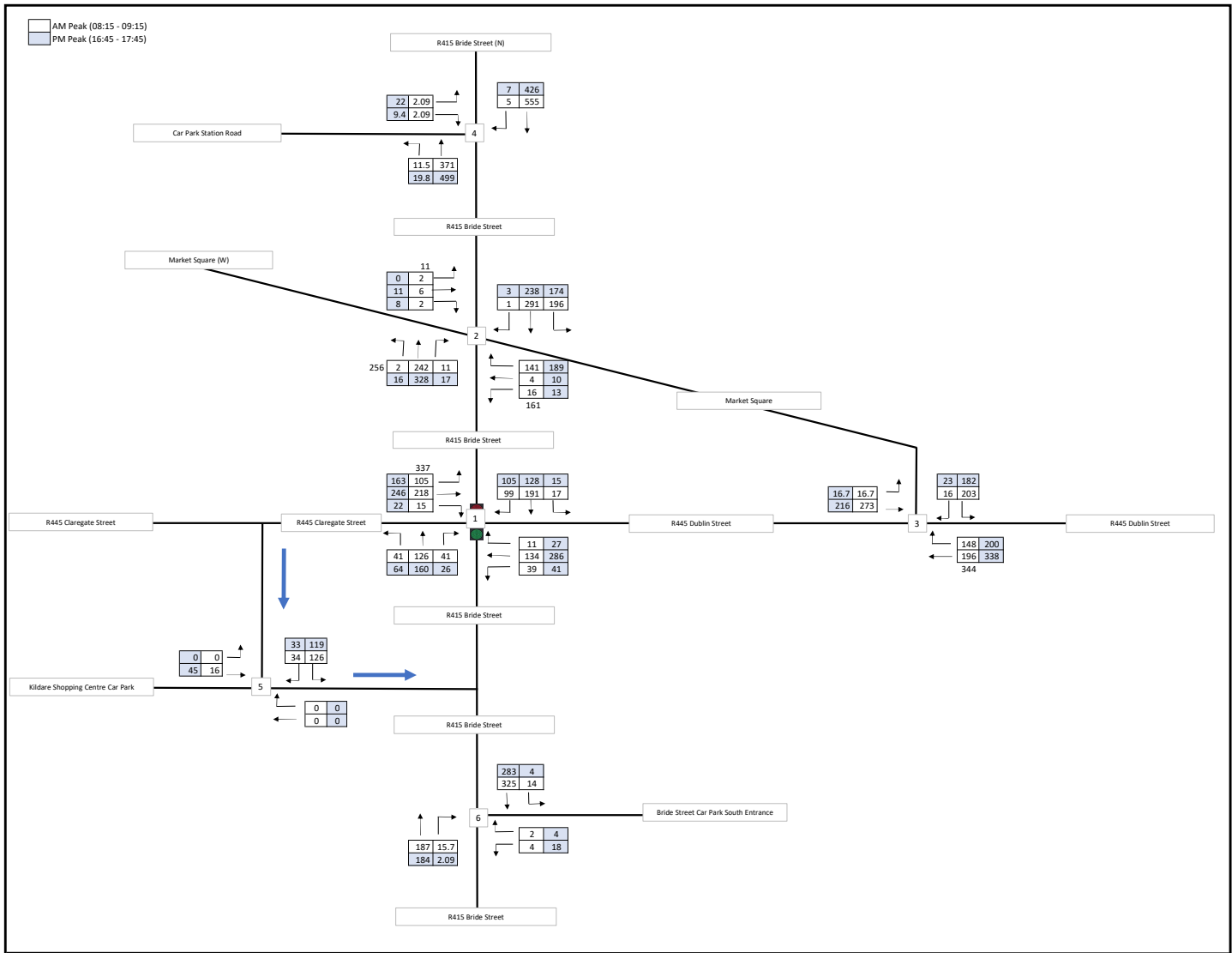

Client:	Kildare County Council	Title:	2029 AM and PM flows	Date:	02/10/2023
Project:	Kildare Market Square	Revision:	1	Design:	JS
			Checked:	JS	
			Approved:	JS	

Taken from LinSig Results

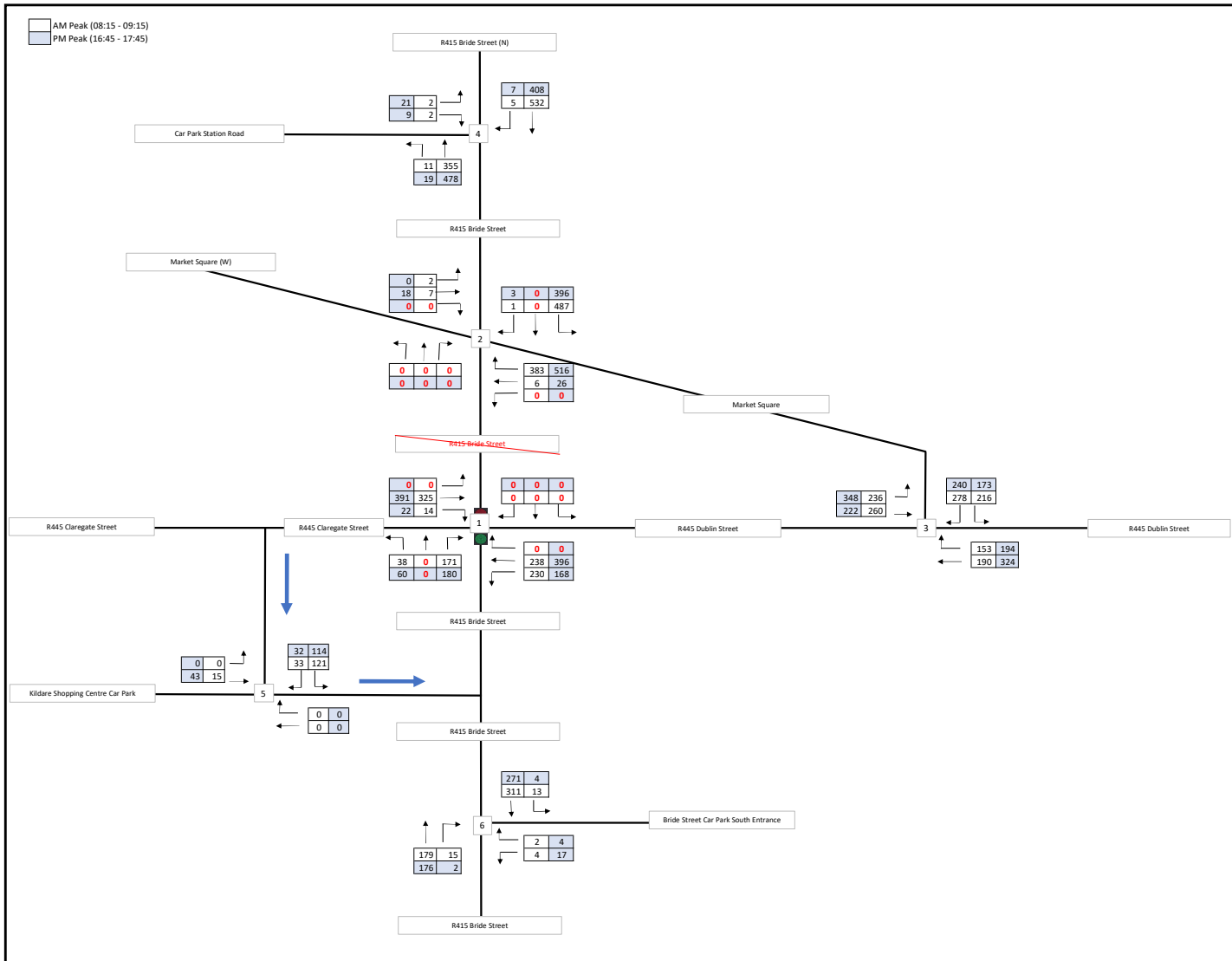

Client:	Kildare County Council	Title:	2029 AM and PM flows - Bride Street Closure (PCUs)	Date:	02/10/2023
Project:	Kildare Market Square			Design:	JS
	AECOM	Revision:	1	Checked:	JS
				Approved:	JS

Taken from LinSig Results

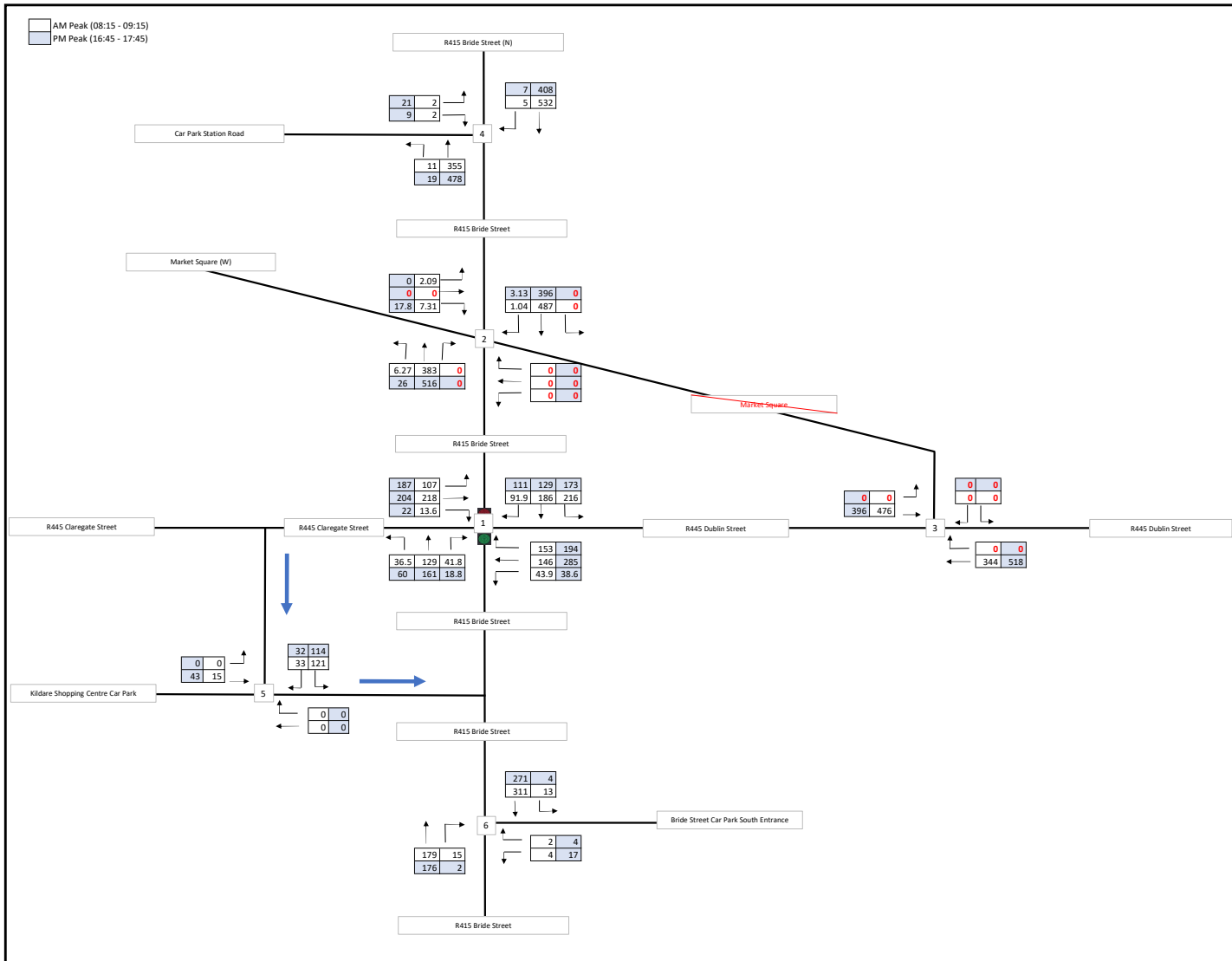

Client:	Kildare County Council	Title:	2029 AM and PM flows - Market Square Closure (PCUs)	Date:	02/10/2023
Project:	Kildare Market Square			Design:	JG
	AECOM	Revision:	1	Checked:	JS
				Approved:	JS

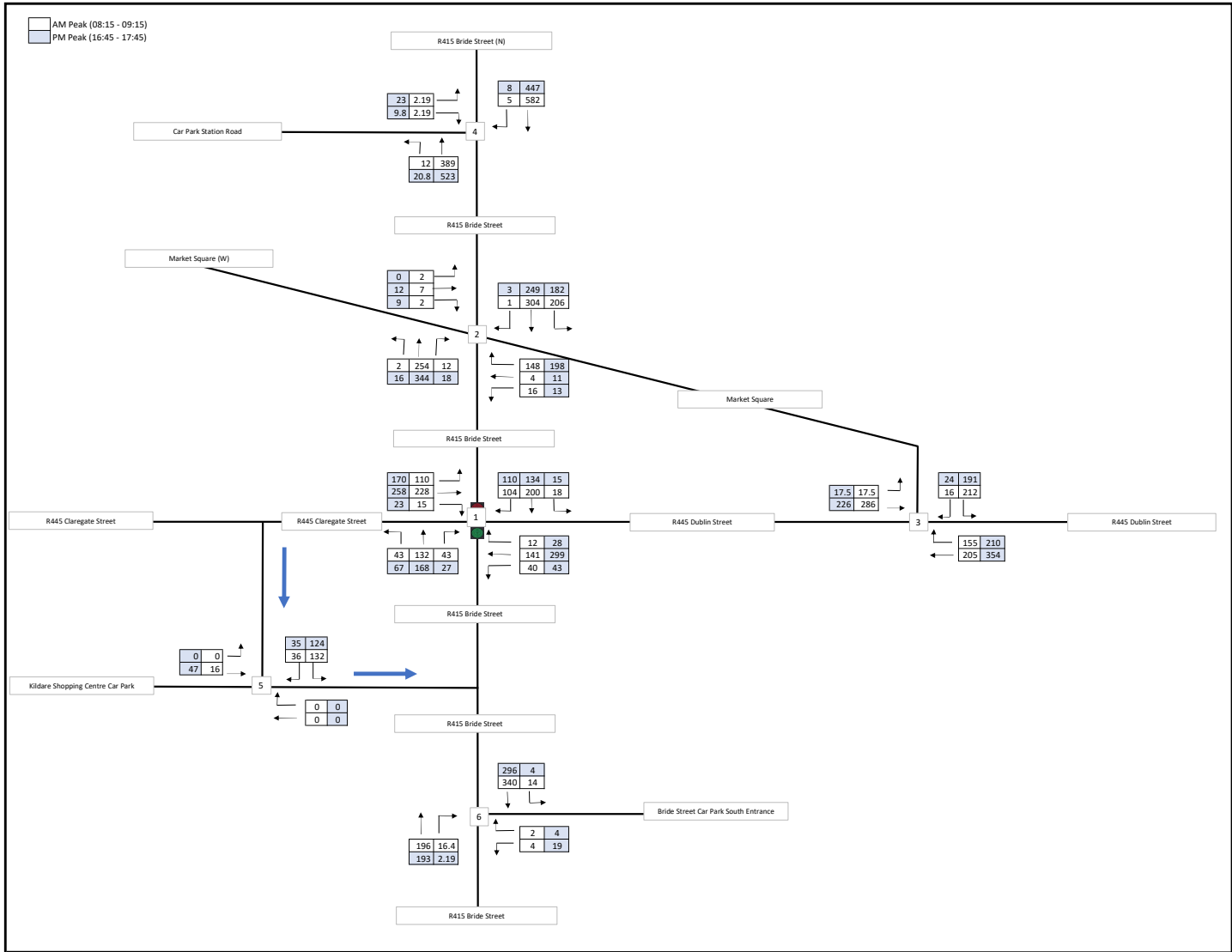

Client:	Kildare County Council	Title:	2039 AM and PM Flows PCUs	Date:	02/10/2023
Project:	Kildare Market Square	Revision:	1	Design:	JS
			Checked:	JS	
			Approved:	JS	



Taken from LinSig Results

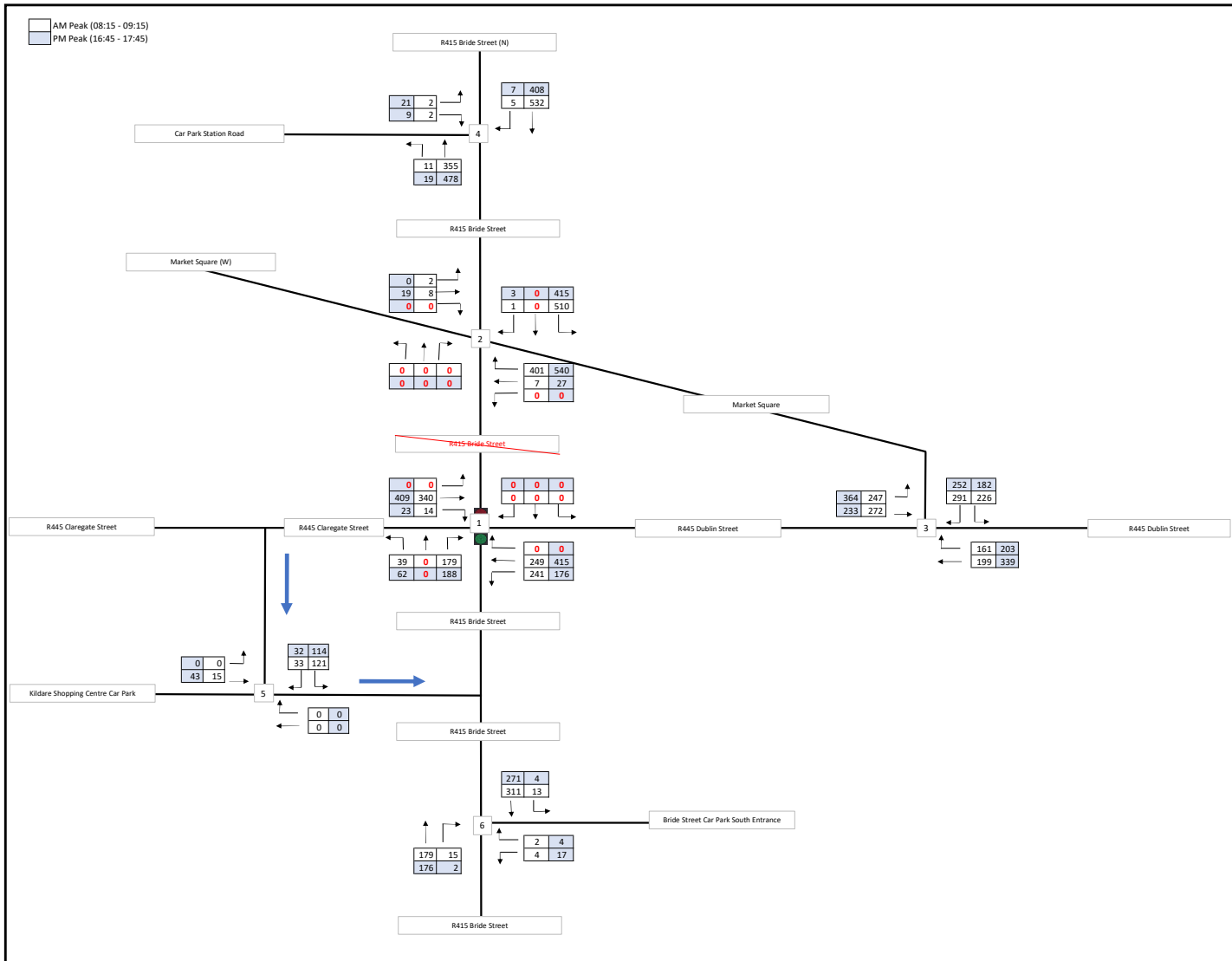

Client:	Kildare County Council	Title:	2039 AM and PM Flows PCUs - Bride Street Closure (PCUs)	Date:	02/10/2023
Project:	Kildare Market Square			Design:	JS
	AECOM	Revision:	1	Checked:	JS
				Approved:	JS

Taken from LinSig Results

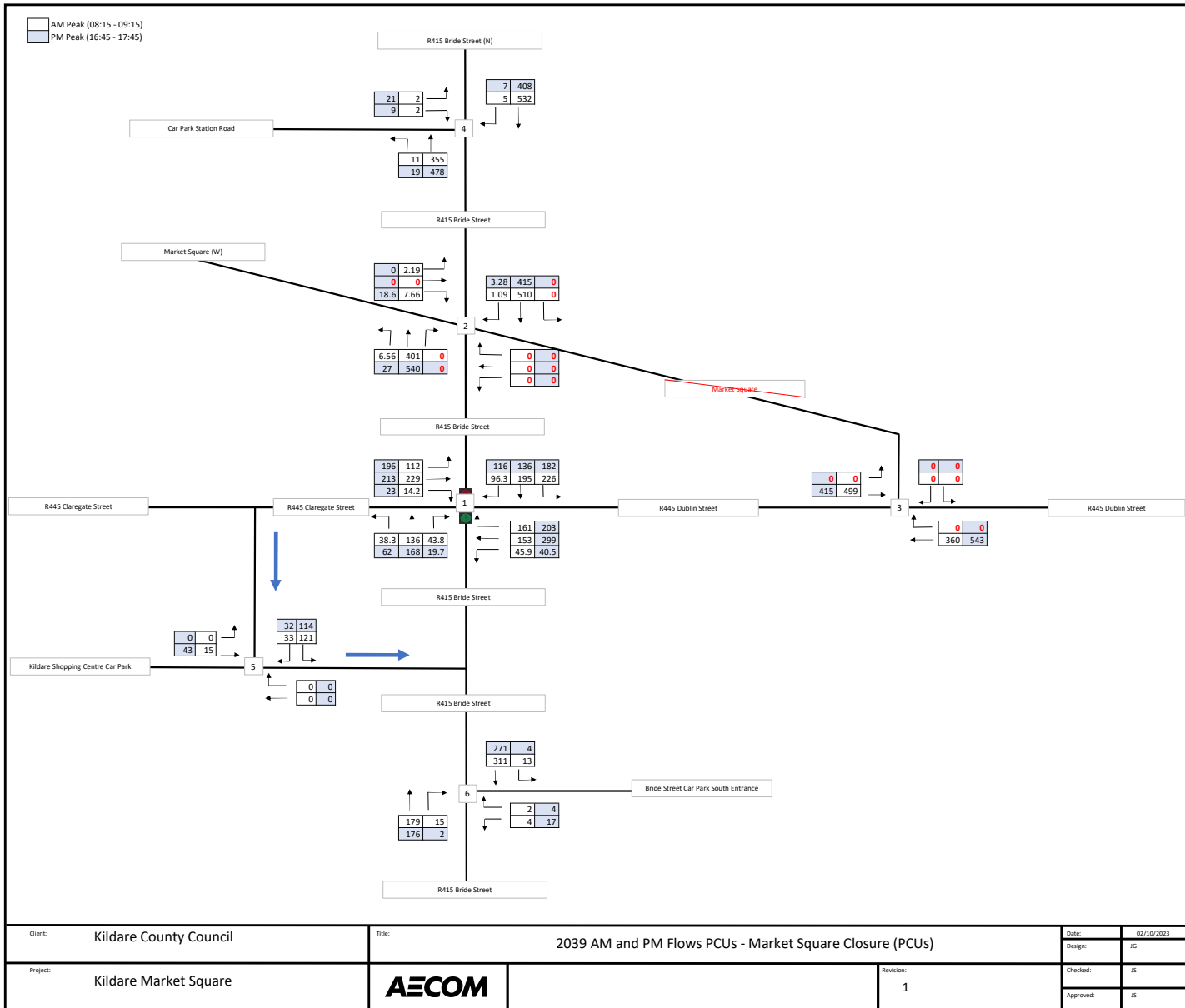

Client:	Kildare County Council	Title:	2039 AM and PM Flows PCUs - Market Square Closure (PCUs)	Date:	02/10/2023
Project:	Kildare Market Square	Revision:	1	Design:	JG
AECOM			Checked:	JS	
			Approved:	JS	

Appendix H Model Results

Basic Results Summary
Basic Results Summary

User and Project Details

Project:	Kildare Market Square
Title:	Proposed Scheme
File name:	Bride Street_Dublin Street Base Model.lsg3x

Scenario 1: 'AM Base' (FG1: 'AM Existing Flows', Plan 1: 'Network Control Plan 1')
Network Layout Diagram

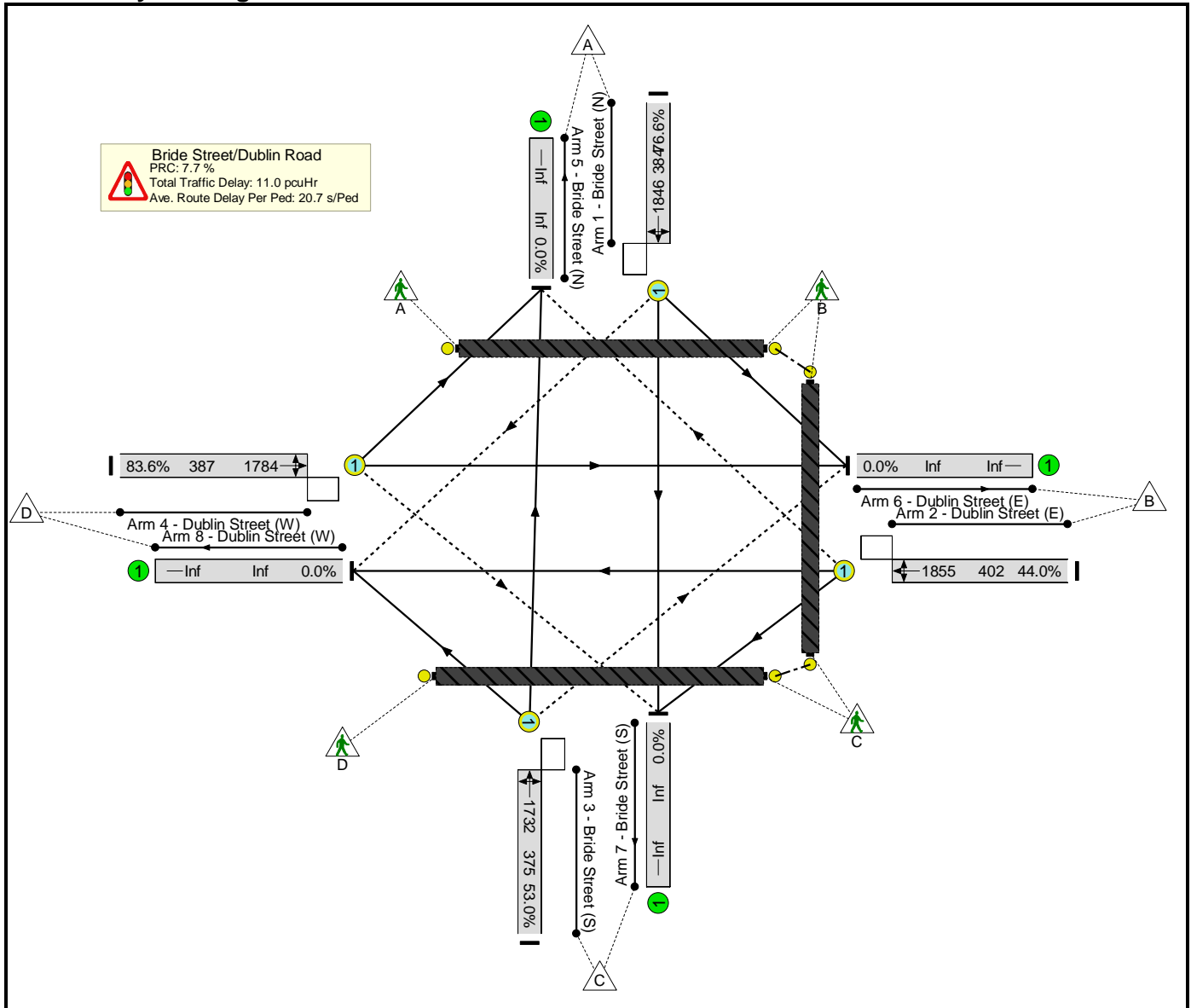

Basic Results Summary

Lane Input Data

Junction: Bride Street/Dublin Road												
Lane	Lane Type	Phases	Start Disp.	End Disp.	Physical Length (PCU)	Sat Flow Type	Def User Saturation Flow (PCU/Hr)	Lane Width (m)	Gradient	Nearside Lane	Turns	Turning Radius (m)
1/1 (Bride Street (N))	O	A	2	3	6.4	Geom	-	4.00	0.00	Y	Arm 6 Left	4.50
											Arm 7 Ahead	Inf
											Arm 8 Right	6.60
2/1 (Dublin Street (E))	O	B	2	3	11.0	Geom	-	3.75	0.00	Y	Arm 5 Right	4.70
											Arm 7 Left	5.90
											Arm 8 Ahead	Inf
3/1 (Bride Street (S))	O	C	2	3	60.0	Geom	-	3.90	0.00	Y	Arm 5 Ahead	Inf
											Arm 6 Right	4.00
											Arm 8 Left	3.50
4/1 (Dublin Street (W))	O	D	2	3	60.0	Geom	-	3.25	0.00	Y	Arm 5 Left	6.10
											Arm 6 Ahead	Inf
											Arm 7 Right	6.00
5/1 (Bride Street (N))	U		2	3	60.0	Inf	-	-	-	-	-	-
6/1 (Dublin Street (E))	U		2	3	60.0	Inf	-	-	-	-	-	-
7/1 (Bride Street (S))	U		2	3	60.0	Inf	-	-	-	-	-	-
8/1 (Dublin Street (W))	U		2	3	60.0	Inf	-	-	-	-	-	-

Basic Results Summary

Phase Diagram

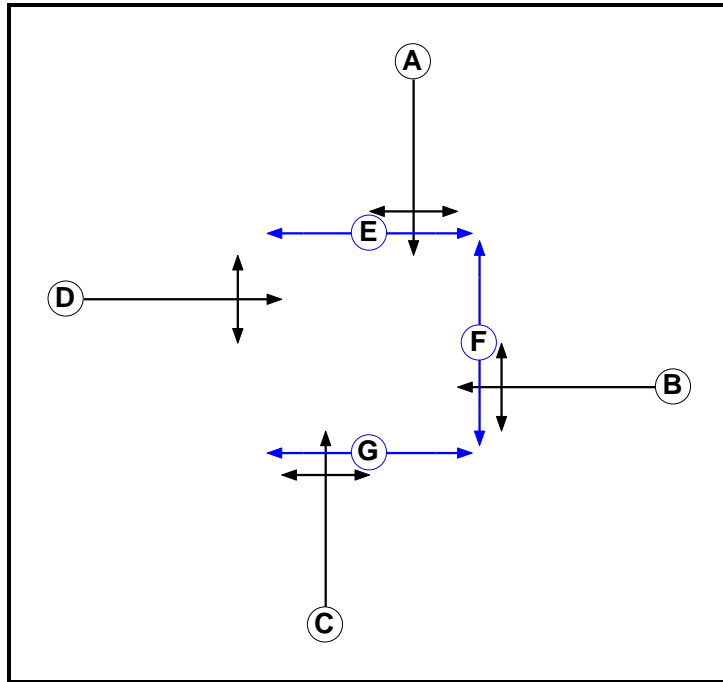

Stage Diagram

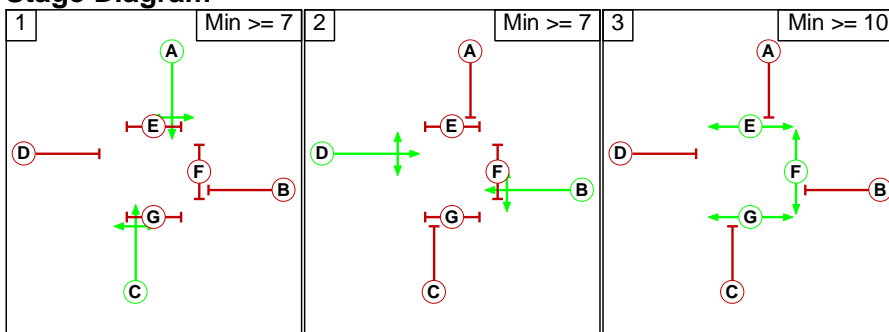

Traffic Flows, Actual
Actual Flow : AM

		Destination				
		A	B	C	D	Tot.
Origin	A	0	16	183	95	294
	B	11	0	37	129	177
	C	121	39	0	39	199
	D	101	208	14	0	323
	Tot.	233	263	234	263	993

Signal Timings Diagram AM

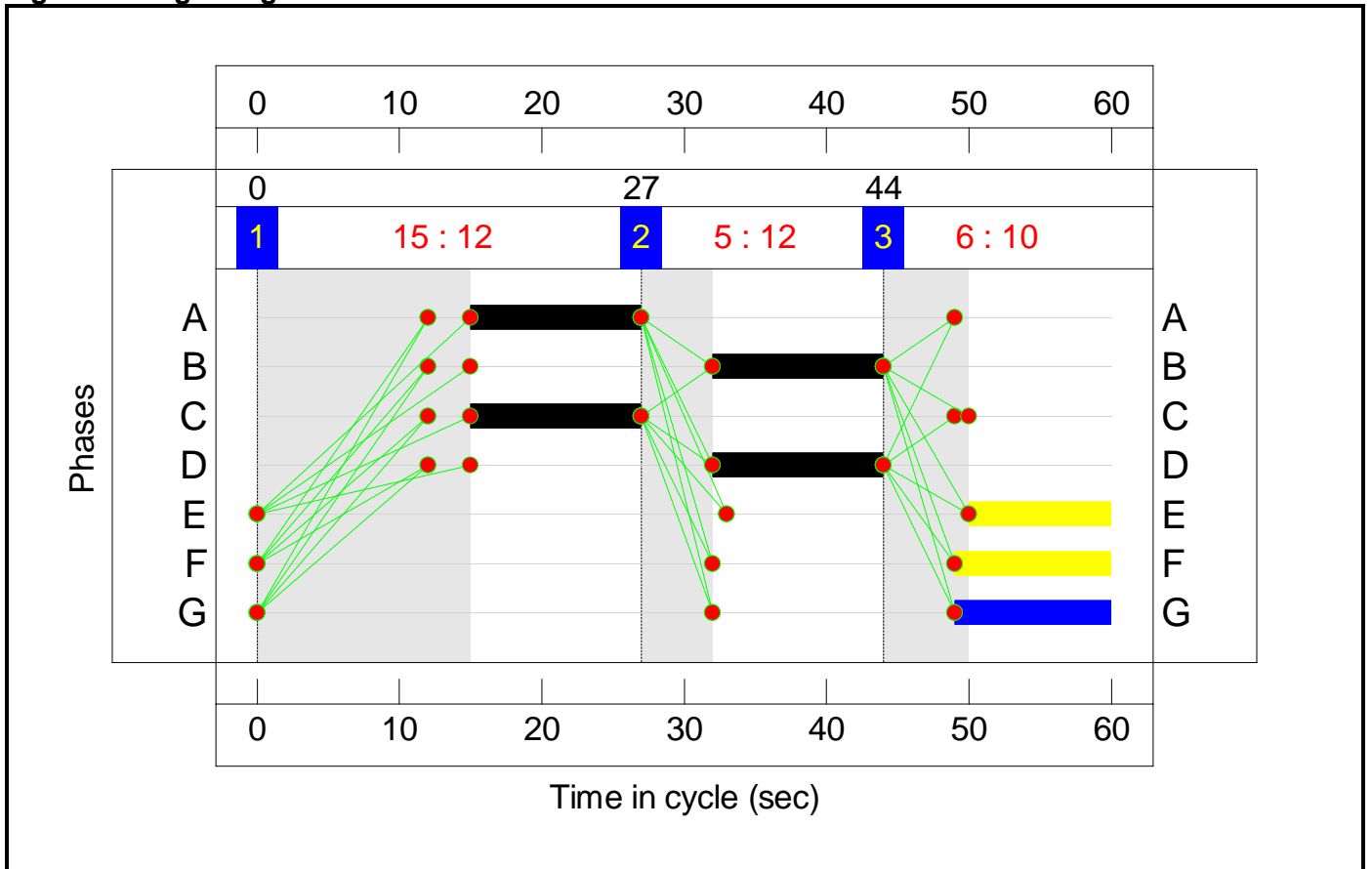

Basic Results Summary
Network Results AM

Item	Lane Description	Lane Type	Full Phase	Arrow Phase	Num Greens	Total Green (s)	Arrow Green (s)	Demand Flow (pcu)	Sat Flow (pcu/Hr)	Capacity (pcu)	Deg Sat (%)	Turners In Gaps (pcu)	Turners When Unopposed (pcu)	Turners In Intergreen (pcu)	Total Delay (pcuHr)	Av. Delay Per PCU (s/pcu)	Mean Max Queue (pcu)	
Network: Proposed Scheme	-	-	-		-	-	-	-	-	-	83.6%	159	0	0	11.0	-	-	
Bride Street/Dublin Road	-	-	-		-	-	-	-	-	-	83.6%	159	0	0	11.0	-	-	
1/1	Bride Street (N) Left Ahead Right	O	A		1	12	-	294	1846	384	76.6%	95	0	0	3.5	42.4	6.1	
2/1	Dublin Street (E) Right Left Ahead	O	B		1	12	-	177	1855	402	44.0%	11	0	0	1.4	28.8	2.9	
3/1	Bride Street (S) Ahead Right Left	O	C		1	12	-	199	1732	375	53.0%	39	0	0	1.8	31.8	3.5	
4/1	Dublin Street (W) Left Ahead Right	O	D		1	12	-	323	1784	387	83.6%	14	0	0	4.4	48.9	7.5	
Ped Link: P1	Unnamed Ped Link	-	E		1	10	-	5	-	12000	0.1%	-	-	-	0.0	21.6	0.1	
Ped Link: P2	Unnamed Ped Link	-	F		1	11	-	83	-	13200	0.3%	-	-	-	0.5	20.7	1.1	
Ped Link: P3	Unnamed Ped Link	-	G		1	11	-	37	-	13200	0.3%	-	-	-	0.2	20.7	0.5	
C1 - Bride Street/Dublin Street				PRC for Signalled Lanes (%): 7.7			PRC Over All Lanes (%): 7.7			Total Delay for Signalled Lanes (pcuHr): 11.02			Total Delay Over All Lanes(pcuHr): 11.02			Cycle Time (s): 60		

Basic Results Summary

Traffic Flows, Actual
Actual Flow : PM

Origin	Destination					
	A	B	C	D	Tot.	
A	0	14	123	101	238	
B	26	0	39	274	339	
C	153	25	0	61	239	
D	156	235	21	0	412	
Tot.	335	274	183	436	1228	

Signal Timings Diagram PM

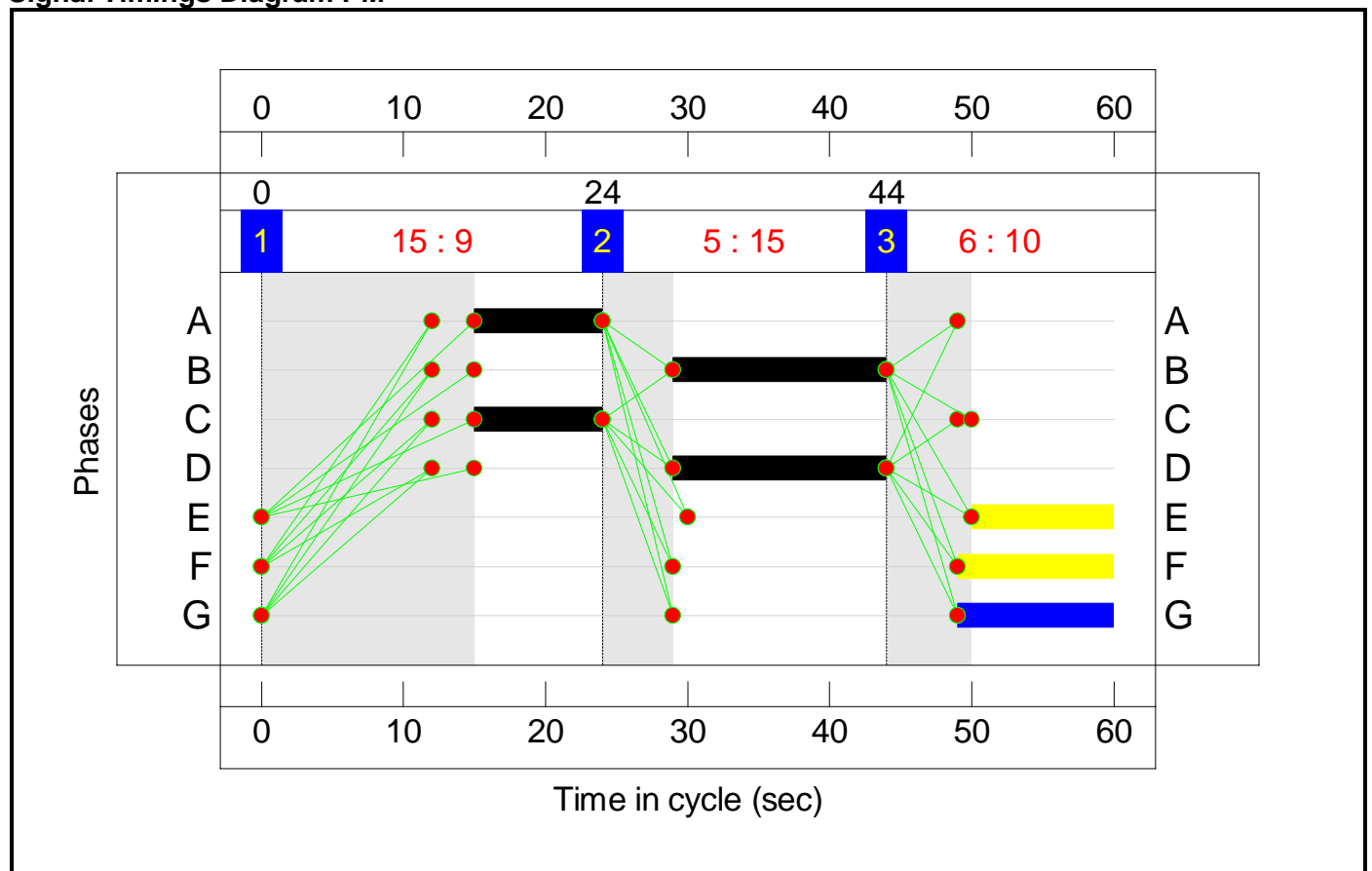

Basic Results Summary
Network Results PM

Item	Lane Description	Lane Type	Full Phase	Arrow Phase	Num Greens	Total Green (s)	Arrow Green (s)	Demand Flow (pcu)	Sat Flow (pcu/Hr)	Capacity (pcu)	Deg Sat (%)	Turners In Gaps (pcu)	Turners When Unopposed (pcu)	Turners In Intergreen (pcu)	Total Delay (pcuHr)	Av. Delay Per PCU (s/pcu)	Mean Max Queue (pcu)
Network: Proposed Scheme	-	-	-		-	-	-	-	-	-	88.1%	112	0	61	16.8	-	-
Bride Street/Dublin Road	-	-	-		-	-	-	-	-	-	88.1%	112	0	61	16.8	-	-
1/1	Bride Street (N) Left Ahead Right	O	A		1	9	-	238	1805	278	85.7%	40	0	61	4.4	66.6	6.4
2/1	Dublin Street (E) Right Left Ahead	O	B		1	15	-	339	1889	504	67.3%	26	0	0	2.9	31.1	6.0
3/1	Bride Street (S) Ahead Right Left	O	C		1	9	-	239	1746	291	82.1%	25	0	0	3.7	56.1	5.9
4/1	Dublin Street (W) Left Ahead Right	O	D		1	15	-	412	1754	468	88.1%	21	0	0	5.7	50.2	9.8
Ped Link: P1	Unnamed Ped Link	-	E		1	10	-	70	-	12000	0.5%	-	-	-	0.4	21.6	1.0
Ped Link: P2	Unnamed Ped Link	-	F		1	11	-	82	-	13200	0.8%	-	-	-	0.5	20.7	1.1
Ped Link: P3	Unnamed Ped Link	-	G		1	11	-	99	-	13200	0.7%	-	-	-	0.6	20.7	1.4
C1 - Bride Street/Dublin Street				PRC for Signalled Lanes (%):		2.2		Total Delay for Signalled Lanes (pcuHr):		16.80		Cycle Time (s):		60			
				PRC Over All Lanes (%):		2.2		Total Delay Over All Lanes(pcuHr):		16.80							

Basic Results Summary
Basic Results Summary

User and Project Details

Project:	Kildare Market Square
Title:	Proposed Scheme
File name:	Bride Street_Dublin Street Proposed Model.lsg3x

Network Layout Diagram

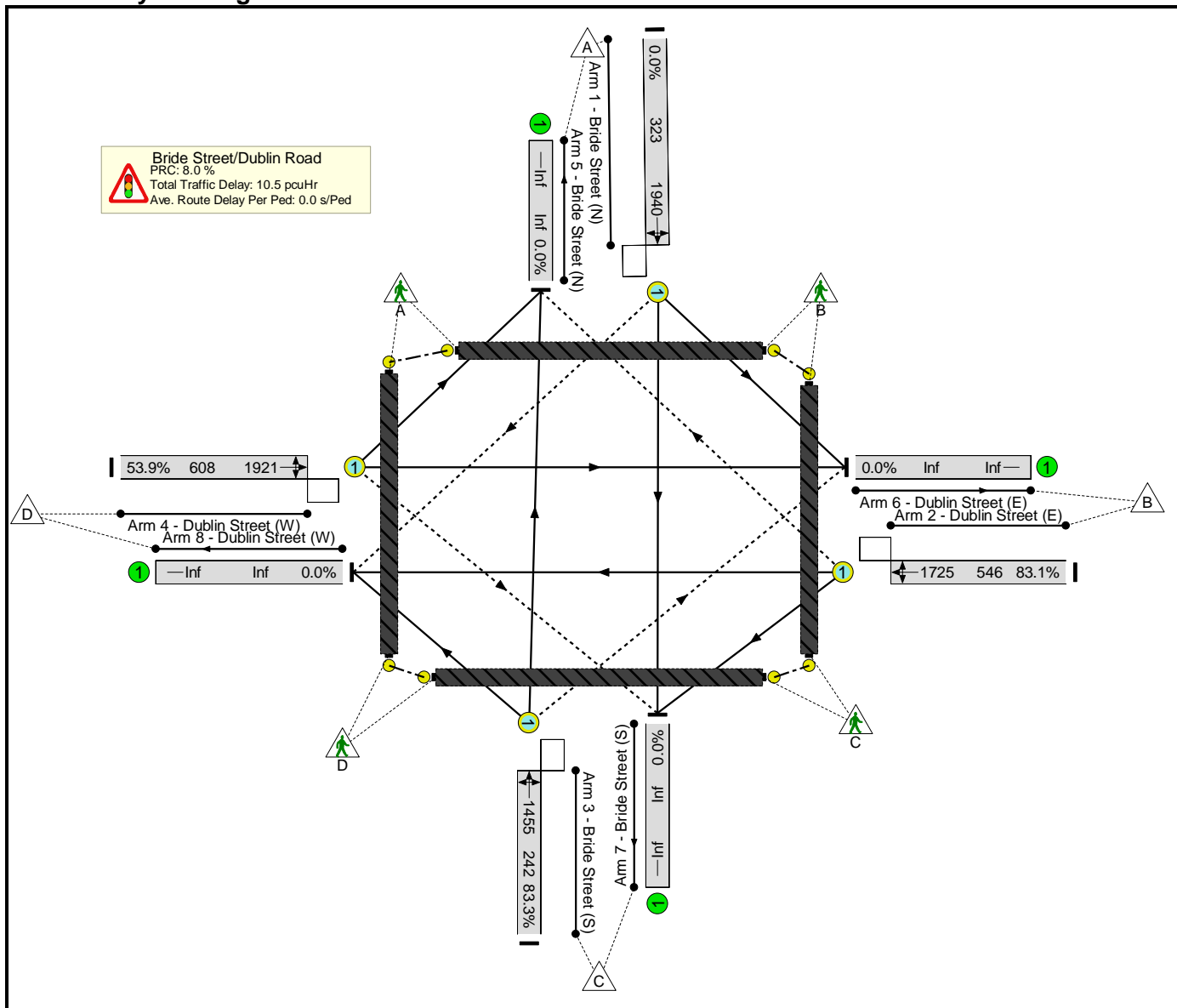

Basic Results Summary

Phase Diagram

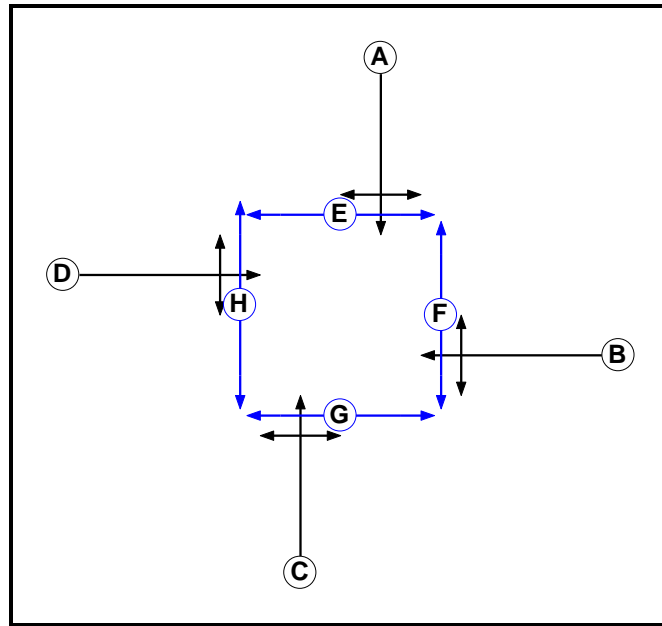

Stage Diagram

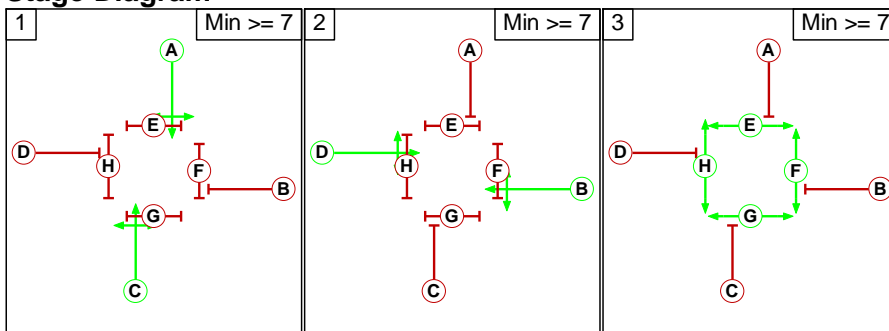

Basic Results Summary

Phase Intergreens Matrix

		Starting Phase							
		A	B	C	D	E	F	G	H
Terminating Phase	A	5	-	5	6	5	6	5	
	B	5	6	-	6	5	6	5	
	C	-	5	5	6	5	6	5	
	D	5	-	5	6	5	6	5	
	E	13	13	13	13	-	-	-	
	F	11	11	11	11	-	-	-	
	G	15	15	15	15	-	-	-	
	H	11	11	11	11	-	-	-	

Traffic Flows, Actual

Scenario 1: '2024 AM Bride Street Close' (FG15: '2024 AM Bride Street Closure', Plan 1: 'Network Control Plan 1')

Actual Flow :

		Destination				
		A	B	C	D	Tot.
Origin	A	0	0	0	0	0
	B	0	0	223	231	454
	C	0	166	0	36	202
	D	0	315	13	0	328
	Tot.	0	481	236	267	984

Scenario 2: '2024 PM Bride Street Close' (FG16: '2024 PM Bride Street Closure', Plan 1: 'Network Control Plan 1')

Actual Flow :

		Destination				
		A	B	C	D	Tot.
Origin	A	0	0	0	0	0
	B	0	0	163	384	547
	C	0	174	0	58	232
	D	0	379	22	0	401
	Tot.	0	553	185	442	1180

Scenario 3: '2024 AM Market Sq Close' (FG21: '2024 AM Market Square Closure', Plan 1: 'Network Control Plan 1')

Actual Flow :

		Destination				
		A	B	C	D	Tot.
Origin	A	0	210	180	89	479
	B	149	0	43	142	334
	C	126	40	0	35	201
	D	103	212	13	0	328
	Tot.	378	462	236	266	1342

Basic Results Summary

Scenario 4: '2024 PM Market Sq Close' (FG22: '2024 PM Market Square Closure', Plan 1: 'Network Control Plan 1')

Actual Flow :

	Destination					
		A	B	C	D	Tot.
Origin	A	0	168	126	107	401
	B	188	0	37	276	501
	C	156	18	0	58	232
	D	181	197	22	0	400
	Tot.	525	383	185	441	1534

Scenario 7: '2029 AM Bride Street Close' (FG17: '2029 AM Bride Street Closure', Plan 1: 'Network Control Plan 1')

Actual Flow :

	Destination					
		A	B	C	D	Tot.
Origin	A	0	0	0	0	0
	B	0	0	230	238	468
	C	0	171	0	38	209
	D	0	325	14	0	339
	Tot.	0	496	244	276	1016

Basic Results Summary

Scenario 8: '2029 PM Bride Street Close' (FG18: '2029 PM Bride Street Closure', Plan 1: 'Network Control Plan 1')

Actual Flow :

	Destination					
		A	B	C	D	Tot.
Origin	A	0	0	0	0	0
	B	0	0	168	396	564
	C	0	180	0	60	240
	D	0	391	22	0	413
	Tot.	0	571	190	456	1217

Scenario 9: '2029 AM Market Sq Close' (FG23: '2029 AM Market Square Closure', Plan 1: 'Network Control Plan 1')

Actual Flow :

	Destination					
		A	B	C	D	Tot.
Origin	A	0	216	186	92	494
	B	153	0	44	146	343
	C	129	42	0	37	208
	D	107	218	14	0	339
	Tot.	389	476	244	275	1384

Scenario 10: '2029 PM Market Sq Close' (FG24: '2029 PM Market Square Closure', Plan 1: 'Network Control Plan 1')

Actual Flow :

	Destination					
		A	B	C	D	Tot.
Origin	A	0	173	129	111	413
	B	194	0	39	285	518
	C	161	19	0	60	240
	D	187	204	22	0	413
	Tot.	542	396	190	456	1584

Scenario 13: '2039 AM Bride Street Close' (FG19: '2039 AM Bride Street Closure', Plan 1: 'Network Control Plan 1')

Actual Flow :

		Destination				
		A	B	C	D	Tot.
Origin	A	0	0	0	0	0
	B	0	0	241	249	490
	C	0	179	0	39	218
	D	0	340	14	0	354
	Tot.	0	519	255	288	1062

Scenario 14: '2039 PM Bride Street Close' (FG20: '2039 PM Bride Street Closure', Plan 1: 'Network Control Plan 1')

Actual Flow :

		Destination				
		A	B	C	D	Tot.
Origin	A	0	0	0	0	0
	B	0	0	176	415	591
	C	0	188	0	62	250
	D	0	409	23	0	432
	Tot.	0	597	199	477	1273

Scenario 15: '2039 AM Market Sq Close' (FG25: '2039 AM Market Square Closure', Plan 1: 'Network Control Plan 1')

Actual Flow :

		Destination				
		A	B	C	D	Tot.
Origin	A	0	226	195	96	517
	B	161	0	46	153	360
	C	136	44	0	38	218
	D	112	229	14	0	355
	Tot.	409	499	255	287	1450

Basic Results Summary

Scenario 16: '2039 PM Market Sq Close' (FG26: '2039 PM Market Square Closure', Plan 1: 'Network Control Plan 1')

Actual Flow :

	Destination					
	A	B	C	D	Tot.	
Origin	A	0	182	136	116	434
	B	203	0	40	229	472
	C	168	20	0	62	250
	D	196	213	23	0	432
	Tot.	567	415	199	407	1588

Basic Results Summary

Network Results

Scenario 1: '2024 AM Bride Street Close' (FG15: '2024 AM Bride Street Closure', Plan 1: 'Network Control Plan 1')

Item	Lane Description	Lane Type	Full Phase	Arrow Phase	Num Greens	Total Green (s)	Arrow Green (s)	Demand Flow (pcu)	Sat Flow (pcu/Hr)	Capacity (pcu)	Deg Sat (%)	Turners In Gaps (pcu)	Turners When Unopposed (pcu)	Turners In Intergreen (pcu)	Total Delay (pcuHr)	Av. Delay Per PCU (s/pcu)	Mean Max Queue (pcu)	
Network: Proposed Scheme	-	-	-		-	-	-	-	-	-	83.3%	179	0	0	10.5	-	-	
Bride Street/Dublin Road	-	-	-		-	-	-	-	-	-	83.3%	179	0	0	10.5	-	-	
1/1	Bride Street (N) Left Ahead Right	O	A		1	9	-	0	1940	323	0.0%	0	0	0	0.0	0.0	0.0	
2/1	Dublin Street (E) Right Left Ahead	O	B		1	18	-	454	1725	546	83.1%	0	0	0	4.7	37.6	9.3	
3/1	Bride Street (S) Ahead Right Left	O	C		1	9	-	202	1455	242	83.3%	166	0	0	3.6	64.2	5.5	
4/1	Dublin Street (W) Left Ahead Right	O	D		1	18	-	328	1921	608	53.9%	13	0	0	2.2	23.7	5.0	
Ped Link: P1	Unnamed Ped Link	-	E		1	7	-	0	-	8400	0.0%	-	-	-	0.0	0.0	0.0	
Ped Link: P2	Unnamed Ped Link	-	F		1	8	-	0	-	9600	0.0%	-	-	-	0.0	0.0	0.0	
Ped Link: P3	Unnamed Ped Link	-	G		1	7	-	0	-	8400	0.0%	-	-	-	0.0	0.0	0.0	
Ped Link: P4	Unnamed Ped Link	-	H		1	8	-	0	-	9600	0.0%	-	-	-	0.0	0.0	0.0	
C1 - Bride Street/Dublin Street				PRC for Signalled Lanes (%):		8.0		Total Delay for Signalled Lanes (pcuHr):				10.50		Cycle Time (s): 60				
				PRC Over All Lanes (%):		8.0		Total Delay Over All Lanes(pcuHr):				10.50						

Basic Results Summary

Scenario 2: '2024 PM Bride Street Close' (FG16: '2024 PM Bride Street Closure', Plan 1: 'Network Control Plan 1')

Item	Lane Description	Lane Type	Full Phase	Arrow Phase	Num Greens	Total Green (s)	Arrow Green (s)	Demand Flow (pcu)	Sat Flow (pcu/Hr)	Capacity (pcu)	Deg Sat (%)	Turners In Gaps (pcu)	Turners When Unopposed (pcu)	Turners In Intergreen (pcu)	Total Delay (pcuHr)	Av. Delay Per PCU (s/pcu)	Mean Max Queue (pcu)
Network: Proposed Scheme	-	-	-		-	-	-	-	-	-	95.9%	188	0	8	20.4	-	-
Bride Street/Dublin Road	-	-	-		-	-	-	-	-	-	95.9%	188	0	8	20.4	-	-
1/1	Bride Street (N) Left Ahead Right	O	A		1	9	-	0	1940	323	0.0%	0	0	0	0.0	0.0	0.0
2/1	Dublin Street (E) Right Left Ahead	O	B		1	18	-	547	1803	571	95.8%	0	0	0	10.2	67.2	16.0
3/1	Bride Street (S) Ahead Right Left	O	C		1	9	-	232	1451	242	95.9%	174	0	0	7.1	110.8	9.3
4/1	Dublin Street (W) Left Ahead Right	O	D		1	18	-	401	1914	606	66.2%	14	0	8	3.0	27.1	6.6
Ped Link: P1	Unnamed Ped Link	-	E		1	7	-	0	-	8400	0.0%	-	-	-	0.0	0.0	0.0
Ped Link: P2	Unnamed Ped Link	-	F		1	8	-	0	-	9600	0.0%	-	-	-	0.0	0.0	0.0
Ped Link: P3	Unnamed Ped Link	-	G		1	7	-	0	-	8400	0.0%	-	-	-	0.0	0.0	0.0
Ped Link: P4	Unnamed Ped Link	-	H		1	8	-	0	-	9600	0.0%	-	-	-	0.0	0.0	0.0
C1 - Bride Street/Dublin Street				PRC for Signalled Lanes (%):		-6.6		Total Delay for Signalled Lanes (pcuHr):				20.37		Cycle Time (s): 60			
				PRC Over All Lanes (%):		-6.6		Total Delay Over All Lanes(pcuHr):				20.37					

Basic Results Summary

Scenario 3: '2024 AM Market Sq Close' (FG21: '2024 AM Market Square Closure', Plan 1: 'Network Control Plan 1')

Item	Lane Description	Lane Type	Full Phase	Arrow Phase	Num Greens	Total Green (s)	Arrow Green (s)	Demand Flow (pcu)	Sat Flow (pcu/Hr)	Capacity (pcu)	Deg Sat (%)	Turners In Gaps (pcu)	Turners When Unopposed (pcu)	Turners In Intergreen (pcu)	Total Delay (pcuHr)	Av. Delay Per PCU (s/pcu)	Mean Max Queue (pcu)
Network: Proposed Scheme	-	-	-		-	-	-	-	-	-	93.9%	278	0	13	20.9	-	-
Bride Street/Dublin Road	-	-	-		-	-	-	-	-	-	93.9%	278	0	13	20.9	-	-
1/1	Bride Street (N) Left Ahead Right	O	A		1	24	-	479	1632	510	93.9%	89	0	0	9.3	69.6	15.9
2/1	Dublin Street (E) Right Left Ahead	O	B		1	23	-	334	1651	367	91.0%	149	0	0	6.9	73.9	11.3
3/1	Bride Street (S) Ahead Right Left	O	C		1	24	-	201	1753	452	44.4%	27	0	13	1.8	32.1	3.9
4/1	Dublin Street (W) Left Ahead Right	O	D		1	23	-	328	1785	536	61.3%	13	0	0	3.0	32.6	7.0
Ped Link: P1	Unnamed Ped Link	-	E		1	7	-	0	-	6300	0.0%	-	-	-	0.0	0.0	0.0
Ped Link: P2	Unnamed Ped Link	-	F		1	8	-	0	-	7200	0.0%	-	-	-	0.0	0.0	0.0
Ped Link: P3	Unnamed Ped Link	-	G		1	7	-	0	-	6300	0.0%	-	-	-	0.0	0.0	0.0
Ped Link: P4	Unnamed Ped Link	-	H		1	8	-	0	-	7200	0.0%	-	-	-	0.0	0.0	0.0
C1 - Bride Street/Dublin Street				PRC for Signalled Lanes (%):		-4.4		Total Delay for Signalled Lanes (pcuHr):		20.88		Cycle Time (s):		80			
				PRC Over All Lanes (%):		-4.4		Total Delay Over All Lanes(pcuHr):		20.88							

Basic Results Summary

Scenario 4: '2024 PM Market Sq Close' (FG22: '2024 PM Market Square Closure', Plan 1: 'Network Control Plan 1')

Item	Lane Description	Lane Type	Full Phase	Arrow Phase	Num Greens	Total Green (s)	Arrow Green (s)	Demand Flow (pcu)	Sat Flow (pcu/Hr)	Capacity (pcu)	Deg Sat (%)	Turners In Gaps (pcu)	Turners When Unopposed (pcu)	Turners In Intergreen (pcu)	Total Delay (pcuHr)	Av. Delay Per PCU (s/pcu)	Mean Max Queue (pcu)
Network: Proposed Scheme	-	-	-		-	-	-	-	-	-	99.8%	335	0	0	31.3	-	-
Bride Street/Dublin Road	-	-	-		-	-	-	-	-	-	99.8%	335	0	0	31.3	-	-
1/1	Bride Street (N) Left Ahead Right	O	A		1	22	-	401	1616	402	99.8%	107	0	0	13.7	122.8	19.8
2/1	Dublin Street (E) Right Left Ahead	O	B		1	35	-	501	1704	516	97.1%	188	0	0	12.2	87.5	20.3
3/1	Bride Street (S) Ahead Right Left	O	C		1	22	-	232	1773	453	51.2%	18	0	0	2.4	36.8	5.5
4/1	Dublin Street (W) Left Ahead Right	O	D		1	35	-	400	1724	690	58.0%	22	0	0	3.0	27.3	8.5
Ped Link: P1	Unnamed Ped Link	-	E		1	7	-	0	-	5600	0.0%	-	-	-	0.0	0.0	0.0
Ped Link: P2	Unnamed Ped Link	-	F		1	8	-	0	-	6400	0.0%	-	-	-	0.0	0.0	0.0
Ped Link: P3	Unnamed Ped Link	-	G		1	7	-	0	-	5600	0.0%	-	-	-	0.0	0.0	0.0
Ped Link: P4	Unnamed Ped Link	-	H		1	8	-	0	-	6400	0.0%	-	-	-	0.0	0.0	0.0
C1 - Bride Street/Dublin Street				PRC for Signalled Lanes (%):		-10.9		Total Delay for Signalled Lanes (pcuHr):				31.26		Cycle Time (s):		90	
				PRC Over All Lanes (%):		-10.9		Total Delay Over All Lanes(pcuHr):				31.26					

Basic Results Summary

Scenario 7: '2029 AM Bride Street Close' (FG17: '2029 AM Bride Street Closure', Plan 1: 'Network Control Plan 1')

Item	Lane Description	Lane Type	Full Phase	Arrow Phase	Num Greens	Total Green (s)	Arrow Green (s)	Demand Flow (pcu)	Sat Flow (pcu/Hr)	Capacity (pcu)	Deg Sat (%)	Turners In Gaps (pcu)	Turners When Unopposed (pcu)	Turners In Intergreen (pcu)	Total Delay (pcuHr)	Av. Delay Per PCU (s/pcu)	Mean Max Queue (pcu)
Network: Proposed Scheme	-	-	-		-	-	-	-	-	-	76.0%	185	0	0	9.1	-	-
Bride Street/Dublin Road	-	-	-		-	-	-	-	-	-	76.0%	185	0	0	9.1	-	-
1/1	Bride Street (N) Left Ahead Right	O	A		1	13	-	0	1940	388	0.0%	0	0	0	0.0	0.0	0.0
2/1	Dublin Street (E) Right Left Ahead	O	B		1	24	-	468	1725	616	76.0%	0	0	0	4.1	31.8	9.5
3/1	Bride Street (S) Ahead Right Left	O	C		1	13	-	209	1455	291	71.8%	171	0	0	2.8	47.5	5.0
4/1	Dublin Street (W) Left Ahead Right	O	D		1	24	-	339	1920	686	49.4%	14	0	0	2.2	23.2	5.6
Ped Link: P1	Unnamed Ped Link	-	E		1	7	-	0	-	7200	0.0%	-	-	-	0.0	0.0	0.0
Ped Link: P2	Unnamed Ped Link	-	F		1	8	-	0	-	8229	0.0%	-	-	-	0.0	0.0	0.0
Ped Link: P3	Unnamed Ped Link	-	G		1	7	-	0	-	7200	0.0%	-	-	-	0.0	0.0	0.0
Ped Link: P4	Unnamed Ped Link	-	H		1	8	-	0	-	8229	0.0%	-	-	-	0.0	0.0	0.0
C1 - Bride Street/Dublin Street				PRC for Signalled Lanes (%):		18.5		Total Delay for Signalled Lanes (pcuHr):				9.07		Cycle Time (s):		70	
				PRC Over All Lanes (%):		18.5		Total Delay Over All Lanes(pcuHr):				9.07					

Basic Results Summary

Scenario 8: '2029 PM Bride Street Close' (FG18: '2029 PM Bride Street Closure', Plan 1: 'Network Control Plan 1')

Item	Lane Description	Lane Type	Full Phase	Arrow Phase	Num Greens	Total Green (s)	Arrow Green (s)	Demand Flow (pcu)	Sat Flow (pcu/Hr)	Capacity (pcu)	Deg Sat (%)	Turners In Gaps (pcu)	Turners When Unopposed (pcu)	Turners In Intergreen (pcu)	Total Delay (pcuHr)	Av. Delay Per PCU (s/pcu)	Mean Max Queue (pcu)
Network: Proposed Scheme	-	-	-		-	-	-	-	-	-	87.6%	202	0	0	13.5	-	-
Bride Street/Dublin Road	-	-	-		-	-	-	-	-	-	87.6%	202	0	0	13.5	-	-
1/1	Bride Street (N) Left Ahead Right	O	A		1	13	-	0	1940	388	0.0%	0	0	0	0.0	0.0	0.0
2/1	Dublin Street (E) Right Left Ahead	O	B		1	24	-	564	1803	644	87.6%	0	0	0	6.6	41.9	13.4
3/1	Bride Street (S) Ahead Right Left	O	C		1	13	-	240	1451	290	82.7%	180	0	0	4.0	59.8	6.7
4/1	Dublin Street (W) Left Ahead Right	O	D		1	24	-	413	1915	684	60.4%	22	0	0	3.0	25.8	7.3
Ped Link: P1	Unnamed Ped Link	-	E		1	7	-	0	-	7200	0.0%	-	-	-	0.0	0.0	0.0
Ped Link: P2	Unnamed Ped Link	-	F		1	8	-	0	-	8229	0.0%	-	-	-	0.0	0.0	0.0
Ped Link: P3	Unnamed Ped Link	-	G		1	7	-	0	-	7200	0.0%	-	-	-	0.0	0.0	0.0
Ped Link: P4	Unnamed Ped Link	-	H		1	8	-	0	-	8229	0.0%	-	-	-	0.0	0.0	0.0
C1 - Bride Street/Dublin Street				PRC for Signalled Lanes (%):		2.8		Total Delay for Signalled Lanes (pcuHr):				13.50		Cycle Time (s):		70	
				PRC Over All Lanes (%):		2.8		Total Delay Over All Lanes(pcuHr):				13.50					

Basic Results Summary

Scenario 9: '2029 AM Market Sq Close' (FG23: '2029 AM Market Square Closure', Plan 1: 'Network Control Plan 1')

Item	Lane Description	Lane Type	Full Phase	Arrow Phase	Num Greens	Total Green (s)	Arrow Green (s)	Demand Flow (pcu)	Sat Flow (pcu/Hr)	Capacity (pcu)	Deg Sat (%)	Turners In Gaps (pcu)	Turners When Unopposed (pcu)	Turners In Intergreen (pcu)	Total Delay (pcuHr)	Av. Delay Per PCU (s/pcu)	Mean Max Queue (pcu)
Network: Proposed Scheme	-	-	-		-	-	-	-	-	-	126.5%	248	0	21	55.4	-	-
Bride Street/Dublin Road	-	-	-		-	-	-	-	-	-	126.5%	248	0	21	55.4	-	-
1/1	Bride Street (N) Left Ahead Right	O	A		1	34	-	494	1633	635	77.8%	92	0	0	5.1	36.8	12.4
2/1	Dublin Street (E) Right Left Ahead	O	B		1	23	-	343	1651	271	126.5%	100	0	21	44.7	468.9	49.4
3/1	Bride Street (S) Ahead Right Left	O	C		1	34	-	208	1749	552	37.7%	42	0	0	1.6	27.7	3.9
4/1	Dublin Street (W) Left Ahead Right	O	D		1	23	-	339	1783	475	71.3%	14	0	0	4.0	42.8	8.8
Ped Link: P1	Unnamed Ped Link	-	E		1	7	-	0	-	5600	0.0%	-	-	-	0.0	0.0	0.0
Ped Link: P2	Unnamed Ped Link	-	F		1	8	-	0	-	6400	0.0%	-	-	-	0.0	0.0	0.0
Ped Link: P3	Unnamed Ped Link	-	G		1	7	-	0	-	5600	0.0%	-	-	-	0.0	0.0	0.0
Ped Link: P4	Unnamed Ped Link	-	H		1	8	-	0	-	6400	0.0%	-	-	-	0.0	0.0	0.0
C1 - Bride Street/Dublin Street				PRC for Signalled Lanes (%):		-40.6		Total Delay for Signalled Lanes (pcuHr):			55.37		Cycle Time (s):		90		
				PRC Over All Lanes (%):		-40.6		Total Delay Over All Lanes(pcuHr):			55.37						

Basic Results Summary

Scenario 10: '2029 PM Market Sq Close' (FG24: '2029 PM Market Square Closure', Plan 1: 'Network Control Plan 1')

Item	Lane Description	Lane Type	Full Phase	Arrow Phase	Num Greens	Total Green (s)	Arrow Green (s)	Demand Flow (pcu)	Sat Flow (pcu/Hr)	Capacity (pcu)	Deg Sat (%)	Turners In Gaps (pcu)	Turners When Unopposed (pcu)	Turners In Intergreen (pcu)	Total Delay (pcuHr)	Av. Delay Per PCU (s/pcu)	Mean Max Queue (pcu)
Network: Proposed Scheme	-	-	-		-	-	-	-	-	-	98.4%	346	0	0	31.6	-	-
Bride Street/Dublin Road	-	-	-		-	-	-	-	-	-	98.4%	346	0	0	31.6	-	-
1/1	Bride Street (N) Left Ahead Right	O	A		1	26	-	413	1616	420	98.4%	111	0	0	12.9	112.8	20.0
2/1	Dublin Street (E) Right Left Ahead	O	B		1	41	-	518	1704	533	97.2%	194	0	0	12.9	89.6	22.3
3/1	Bride Street (S) Ahead Right Left	O	C		1	26	-	240	1772	478	50.2%	19	0	0	2.6	38.3	6.1
4/1	Dublin Street (W) Left Ahead Right	O	D		1	41	-	413	1725	725	57.0%	22	0	0	3.2	27.9	9.4
Ped Link: P1	Unnamed Ped Link	-	E		1	7	-	0	-	5040	0.0%	-	-	-	0.0	0.0	0.0
Ped Link: P2	Unnamed Ped Link	-	F		1	8	-	0	-	5760	0.0%	-	-	-	0.0	0.0	0.0
Ped Link: P3	Unnamed Ped Link	-	G		1	7	-	0	-	5040	0.0%	-	-	-	0.0	0.0	0.0
Ped Link: P4	Unnamed Ped Link	-	H		1	8	-	0	-	5760	0.0%	-	-	-	0.0	0.0	0.0
C1 - Bride Street/Dublin Street				PRC for Signalled Lanes (%):		-9.4		Total Delay for Signalled Lanes (pcuHr):				31.58		Cycle Time (s): 100			
				PRC Over All Lanes (%):		-9.4		Total Delay Over All Lanes(pcuHr):				31.58					

Basic Results Summary

Scenario 13: '2039 AM Bride Street Close' (FG19: '2039 AM Bride Street Closure', Plan 1: 'Network Control Plan 1')

Item	Lane Description	Lane Type	Full Phase	Arrow Phase	Num Greens	Total Green (s)	Arrow Green (s)	Demand Flow (pcu)	Sat Flow (pcu/Hr)	Capacity (pcu)	Deg Sat (%)	Turners In Gaps (pcu)	Turners When Unopposed (pcu)	Turners In Intergreen (pcu)	Total Delay (pcuHr)	Av. Delay Per PCU (s/pcu)	Mean Max Queue (pcu)
Network: Proposed Scheme	-	-	-		-	-	-	-	-	-	79.6%	193	0	0	10.0	-	-
Bride Street/Dublin Road	-	-	-		-	-	-	-	-	-	79.6%	193	0	0	10.0	-	-
1/1	Bride Street (N) Left Ahead Right	O	A		1	13	-	0	1940	388	0.0%	0	0	0	0.0	0.0	0.0
2/1	Dublin Street (E) Right Left Ahead	O	B		1	24	-	490	1724	616	79.6%	0	0	0	4.6	34.1	10.3
3/1	Bride Street (S) Ahead Right Left	O	C		1	13	-	218	1455	291	74.9%	179	0	0	3.0	50.1	5.4
4/1	Dublin Street (W) Left Ahead Right	O	D		1	24	-	354	1921	686	51.6%	14	0	0	2.3	23.6	5.9
Ped Link: P1	Unnamed Ped Link	-	E		1	7	-	0	-	7200	0.0%	-	-	-	0.0	0.0	0.0
Ped Link: P2	Unnamed Ped Link	-	F		1	8	-	0	-	8229	0.0%	-	-	-	0.0	0.0	0.0
Ped Link: P3	Unnamed Ped Link	-	G		1	7	-	0	-	7200	0.0%	-	-	-	0.0	0.0	0.0
Ped Link: P4	Unnamed Ped Link	-	H		1	8	-	0	-	8229	0.0%	-	-	-	0.0	0.0	0.0
C1 - Bride Street/Dublin Street				PRC for Signalled Lanes (%):		13.1		Total Delay for Signalled Lanes (pcuHr):				9.99		Cycle Time (s):		70	
				PRC Over All Lanes (%):		13.1		Total Delay Over All Lanes(pcuHr):				9.99					

Basic Results Summary

Scenario 14: '2039 PM Bride Street Close' (FG20: '2039 PM Bride Street Closure', Plan 1: 'Network Control Plan 1')

Item	Lane Description	Lane Type	Full Phase	Arrow Phase	Num Greens	Total Green (s)	Arrow Green (s)	Demand Flow (pcu)	Sat Flow (pcu/Hr)	Capacity (pcu)	Deg Sat (%)	Turners In Gaps (pcu)	Turners When Unopposed (pcu)	Turners In Intergreen (pcu)	Total Delay (pcuHr)	Av. Delay Per PCU (s/pcu)	Mean Max Queue (pcu)
Network: Proposed Scheme	-	-	-		-	-	-	-	-	-	91.8%	211	0	0	16.1	-	-
Bride Street/Dublin Road	-	-	-		-	-	-	-	-	-	91.8%	211	0	0	16.1	-	-
1/1	Bride Street (N) Left Ahead Right	O	A		1	13	-	0	1940	388	0.0%	0	0	0	0.0	0.0	0.0
2/1	Dublin Street (E) Right Left Ahead	O	B		1	24	-	591	1803	644	91.8%	0	0	0	8.3	50.4	15.6
3/1	Bride Street (S) Ahead Right Left	O	C		1	13	-	250	1451	290	86.1%	188	0	0	4.6	66.5	7.4
4/1	Dublin Street (W) Left Ahead Right	O	D		1	24	-	432	1915	684	63.2%	23	0	0	3.2	26.5	7.8
Ped Link: P1	Unnamed Ped Link	-	E		1	7	-	0	-	7200	0.0%	-	-	-	0.0	0.0	0.0
Ped Link: P2	Unnamed Ped Link	-	F		1	8	-	0	-	8229	0.0%	-	-	-	0.0	0.0	0.0
Ped Link: P3	Unnamed Ped Link	-	G		1	7	-	0	-	7200	0.0%	-	-	-	0.0	0.0	0.0
Ped Link: P4	Unnamed Ped Link	-	H		1	8	-	0	-	8229	0.0%	-	-	-	0.0	0.0	0.0
C1 - Bride Street/Dublin Street				PRC for Signalled Lanes (%):		-2.0		Total Delay for Signalled Lanes (pcuHr):				16.07		Cycle Time (s):		70	
				PRC Over All Lanes (%):		-2.0		Total Delay Over All Lanes(pcuHr):				16.07					

Basic Results Summary

Scenario 15: '2039 AM Market Sq Close' (FG25: '2039 AM Market Square Closure', Plan 1: 'Network Control Plan 1')

Item	Lane Description	Lane Type	Full Phase	Arrow Phase	Num Greens	Total Green (s)	Arrow Green (s)	Demand Flow (pcu)	Sat Flow (pcu/Hr)	Capacity (pcu)	Deg Sat (%)	Turners In Gaps (pcu)	Turners When Unopposed (pcu)	Turners In Intergreen (pcu)	Total Delay (pcuHr)	Av. Delay Per PCU (s/pcu)	Mean Max Queue (pcu)
Network: Proposed Scheme	-	-	-		-	-	-	-	-	-	91.8%	315	0	0	22.4	-	-
Bride Street/Dublin Road	-	-	-		-	-	-	-	-	-	91.8%	315	0	0	22.4	-	-
1/1	Bride Street (N) Left Ahead Right	O	A		1	34	-	517	1633	572	90.5%	96	0	0	8.6	59.9	17.8
2/1	Dublin Street (E) Right Left Ahead	O	B		1	33	-	360	1651	392	91.8%	161	0	0	8.0	80.0	14.1
3/1	Bride Street (S) Ahead Right Left	O	C		1	34	-	218	1752	374	58.3%	44	0	0	2.4	40.2	5.2
4/1	Dublin Street (W) Left Ahead Right	O	D		1	33	-	355	1784	607	58.5%	14	0	0	3.4	34.3	8.8
Ped Link: P1	Unnamed Ped Link	-	E		1	7	-	0	-	5040	0.0%	-	-	-	0.0	0.0	0.0
Ped Link: P2	Unnamed Ped Link	-	F		1	8	-	0	-	5760	0.0%	-	-	-	0.0	0.0	0.0
Ped Link: P3	Unnamed Ped Link	-	G		1	7	-	0	-	5040	0.0%	-	-	-	0.0	0.0	0.0
Ped Link: P4	Unnamed Ped Link	-	H		1	8	-	0	-	5760	0.0%	-	-	-	0.0	0.0	0.0
C1 - Bride Street/Dublin Street				PRC for Signalled Lanes (%):		-2.0		Total Delay for Signalled Lanes (pcuHr):		22.42		Cycle Time (s):		100			
				PRC Over All Lanes (%):		-2.0		Total Delay Over All Lanes(pcuHr):		22.42							

Basic Results Summary

Scenario 16: '2039 PM Market Sq Close' (FG26: '2039 PM Market Square Closure', Plan 1: 'Network Control Plan 1')

Item	Lane Description	Lane Type	Full Phase	Arrow Phase	Num Greens	Total Green (s)	Arrow Green (s)	Demand Flow (pcu)	Sat Flow (pcu/Hr)	Capacity (pcu)	Deg Sat (%)	Turners In Gaps (pcu)	Turners When Unopposed (pcu)	Turners In Intergreen (pcu)	Total Delay (pcuHr)	Av. Delay Per PCU (s/pcu)	Mean Max Queue (pcu)
Network: Proposed Scheme	-	-	-		-	-	-	-	-	-	98.7%	362	0	0	33.6	-	-
Bride Street/Dublin Road	-	-	-		-	-	-	-	-	-	98.7%	362	0	0	33.6	-	-
1/1	Bride Street (N) Left Ahead Right	O	A		1	29	-	434	1616	442	98.2%	116	0	0	13.2	109.9	21.2
2/1	Dublin Street (E) Right Left Ahead	O	B		1	43	-	472	1674	478	98.7%	203	0	0	14.1	107.5	23.0
3/1	Bride Street (S) Ahead Right Left	O	C		1	29	-	250	1773	507	49.4%	20	0	0	2.7	38.2	6.5
4/1	Dublin Street (W) Left Ahead Right	O	D		1	43	-	432	1725	723	59.8%	23	0	0	3.6	29.8	10.5
Ped Link: P1	Unnamed Ped Link	-	E		1	7	-	0	-	4800	0.0%	-	-	-	0.0	0.0	0.0
Ped Link: P2	Unnamed Ped Link	-	F		1	8	-	0	-	5486	0.0%	-	-	-	0.0	0.0	0.0
Ped Link: P3	Unnamed Ped Link	-	G		1	7	-	0	-	4800	0.0%	-	-	-	0.0	0.0	0.0
Ped Link: P4	Unnamed Ped Link	-	H		1	8	-	0	-	5486	0.0%	-	-	-	0.0	0.0	0.0
C1 - Bride Street/Dublin Street				PRC for Signalled Lanes (%):		-9.6		Total Delay for Signalled Lanes (pcuHr):				33.56		Cycle Time (s): 105			
				PRC Over All Lanes (%):		-9.6		Total Delay Over All Lanes(pcuHr):				33.56					

<h1>Junctions 10</h1>
<h2>PICADY 10 - Priority Intersection Module</h2>
Version: 10.0.4.1693 © Copyright TRL Software Limited, 2021
For sales and distribution information, program advice and maintenance, contact TRL Software: +44 (0)1344 379777 software@trl.co.uk trlsoftware.com
The users of this computer program for the solution of an engineering problem are in no way relieved of their responsibility for the correctness of the solution

Filename: Market Square _ Bride Closure Model.j10

Path: \\na.aecomnet.com\lfs\EMEA\Dublin-IEDBL1\Legacy\IEDBL1FP001\UFI\Jobs\PR-384133_Kildare-Newbridge-Town\400_Technical\404_CE\01_Traffic\05_Reports\03_TTA KMS\Flow Diagram and Modelling\Models

Report generation date: 20/12/2023 09:55:35

-
- »2023, AM
 - »2023, PM
 - »2024 Bride Street Closure, AM
 - »2024 Bride Street Closure, PM
 - »2024 Market Sq Closure, AM
 - »2024 Market Sq Closure, PM
 - »2024 Right Turn Ban, AM
 - »2024 Right Turn Ban, PM
 - »2029 Bride Street Closure, AM
 - »2029 Bride Street Closure, PM
 - »2029 Market Sq Closure, AM
 - »2029 Market Sq Closure, PM
 - »2039 Bride Street Closure, AM
 - »2039 Bride Street Closure, PM
 - »2039 Market Sq Closure, AM
 - »2039 Market Sq Closure, PM

Summary of junction performance

	AM					PM				
	Set ID	Queue (PCU)	Delay (s)	RFC	LOS	Set ID	Queue (PCU)	Delay (s)	RFC	LOS
2023										
Stream B-ACD	D1	0.7	16.04	0.43	C	D2	1.3	21.90	0.58	C
Stream A-BCD		0.0	4.53	0.00	A		0.0	4.84	0.01	A
Stream D-ABC		0.0	9.83	0.03	A		0.1	11.48	0.06	B
Stream C-ABD		0.0	5.69	0.03	A		0.1	5.23	0.04	A
2024 Bride Street Closure										
Stream B-ACD	D3	6.4	59.72	0.89	F	D4	63.3	477.05	1.22	F
Stream A-BCD		0.0	4.30	0.00	A		0.0	4.55	0.01	A
Stream D-ABC		0.0	8.40	0.02	A		0.0	9.02	0.04	A
Stream C-ABD		0.0	0.00	0.00	A		0.0	0.00	0.00	A
2024 Market Sq Closure										
Stream B-ACD	D5	0.0	0.00	0.00	A	D6	0.0	0.00	0.00	A
Stream A-BCD		0.0	4.63	0.00	A		0.0	5.06	0.01	A
Stream D-ABC		0.0	10.73	0.03	B		0.1	13.00	0.06	B
Stream C-ABD		0.0	0.00	0.00	A		0.0	0.00	0.00	A
2024 Right Turn Ban										
Stream B-ACD	D7	0.7	15.76	0.43	C	D8	1.3	21.15	0.57	C
Stream A-BCD		0.0	4.51	0.00	A		0.0	4.82	0.01	A
Stream D-ABC		0.0	9.76	0.03	A		0.1	11.34	0.06	B
Stream C-ABD		0.0	0.00	0.00	A		0.0	0.00	0.00	A
2029 Bride Street Closure										
Stream B-ACD	D9	7.7	69.27	0.92	F	D10	77.7	582.64	1.26	F
Stream A-BCD		0.0	4.26	0.00	A		0.0	4.51	0.01	A
Stream D-ABC		0.0	0.00	0.00	A		0.0	9.09	0.05	A
Stream C-ABD		0.0	0.00	0.00	A		0.0	0.00	0.00	A
2029 Market Sq Closure										
Stream B-ACD	D11	0.0	0.00	0.00	A	D12	0.0	0.00	0.00	A
Stream A-BCD		0.0	4.59	0.00	A		0.0	5.01	0.01	A
Stream D-ABC		0.0	10.88	0.03	B		0.1	13.33	0.07	B
Stream C-ABD		0.0	0.00	0.00	A		0.0	0.00	0.00	A
2039 Bride Street Closure										
Stream B-ACD	D13	11.9	99.86	0.97	F	D14	102.6	748.81	1.33	F
Stream A-BCD		0.0	4.20	0.00	A		0.0	4.46	0.01	A
Stream D-ABC		0.0	8.60	0.03	A		0.1	9.18	0.05	A
Stream C-ABD		0.0	0.00	0.00	A		0.0	0.00	0.00	A
2039 Market Sq Closure										
Stream B-ACD	D15	0.0	0.00	0.00	A	D16	0.0	0.00	0.00	A
Stream A-BCD		0.0	4.54	0.00	A		0.0	4.99	0.01	A
Stream D-ABC		0.0	11.30	0.03	B		0.1	13.84	0.07	B
Stream C-ABD		0.0	0.00	0.00	A		0.0	0.00	0.00	A

There are warnings associated with one or more model runs - see the 'Data Errors and Warnings' tables for each Analysis or Demand Set.

Values shown are the highest values encountered over all time segments. Delay is the maximum value of average delay per arriving vehicle.

File summary

File Description

Title	
Location	
Site number	
Date	20/12/2023
Version	
Status	(new file)
Identifier	
Client	
Jobnumber	
Enumerator	NA\SimmonsA1
Description	

Units

Distance units	Speed units	Traffic units input	Traffic units results	Flow units	Average delay units	Total delay units	Rate of delay units
m	kph	PCU	PCU	perHour	s	-Min	perMin

Analysis Options

Calculate Queue Percentiles	Calculate residual capacity	RFC Threshold	Average Delay threshold (s)	Queue threshold (PCU)
		0.85	36.00	20.00

Demand Set Summary

ID	Scenario name	Time Period name	Traffic profile type	Start time (HH:mm)	Finish time (HH:mm)	Time segment length (min)
D1	2023	AM	ONE HOUR	08:15	09:45	15
D2	2023	PM	ONE HOUR	16:45	18:15	15
D3	2024 Bride Street Closure	AM	ONE HOUR	08:15	09:45	15
D4	2024 Bride Street Closure	PM	ONE HOUR	16:45	18:15	15
D5	2024 Market Sq Closure	AM	ONE HOUR	08:15	09:45	15
D6	2024 Market Sq Closure	PM	ONE HOUR	16:45	18:15	15
D7	2024 Right Turn Ban	AM	ONE HOUR	08:15	09:45	15
D8	2024 Right Turn Ban	PM	ONE HOUR	16:45	18:15	15
D9	2029 Bride Street Closure	AM	ONE HOUR	08:15	09:45	15
D10	2029 Bride Street Closure	PM	ONE HOUR	16:45	18:15	15
D11	2029 Market Sq Closure	AM	ONE HOUR	08:15	09:45	15
D12	2029 Market Sq Closure	PM	ONE HOUR	16:45	18:15	15
D13	2039 Bride Street Closure	AM	ONE HOUR	08:15	09:45	15
D14	2039 Bride Street Closure	PM	ONE HOUR	16:45	18:15	15
D15	2039 Market Sq Closure	AM	ONE HOUR	08:15	09:45	15
D16	2039 Market Sq Closure	PM	ONE HOUR	16:45	18:15	15

Analysis Set Details

ID	Network flow scaling factor (%)
A1	100.000

2023, AM

Data Errors and Warnings

No errors or warnings

Junction Network

Junctions

Junction	Name	Junction type	Arm A Direction	Arm B Direction	Arm C Direction	Arm D Direction	Use circulating lanes	Junction Delay (s)	Junction LOS
1	untitled	Crossroads	Two-way	Two-way	Two-way	Two-way		3.05	A

Junction Network

Driving side	Lighting	Network delay (s)	Network LOS
Left	Normal/unknown	3.05	A

Arms

Arms

Arm	Name	Description	Arm type
A	untitled		Major
B	untitled		Minor
C	untitled		Major
D	untitled		Minor

Major Arm Geometry

Arm	Width of carriageway (m)	Has kerbed central reserve	Has right-turn storage	Visibility for right turn (m)	Blocks?	Blocking queue (PCU)
A	6.20			50.0	✓	0.00
C	6.20			50.0	✓	0.00

Geometries for Arm C are measured opposite Arm B. Geometries for Arm A (if relevant) are measured opposite Arm D.

Minor Arm Geometry

Arm	Minor arm type	Lane width (m)	Visibility to left (m)	Visibility to right (m)
B	One lane	2.90	50	60
D	One lane	2.40	15	50

Slope / Intercept / Capacity

Priority Intersection Slopes and Intercepts

Stream	Intercept (PCU/hr)	Slope for A-B	Slope for A-C	Slope for A-D	Slope for B-A	Slope for B-C	Slope for B-D	Slope for C-A	Slope for C-B	Slope for C-D	Slope for D-A	Slope for D-B	Slope for D-C
A-D	603	-	-	-	-	-	-	0.232	0.331	0.232	-	-	-
B-A	518	0.094	0.237	0.237	-	-	-	0.149	0.338	-	0.237	0.237	0.118
B-C	655	0.100	0.252	-	-	-	-	-	-	-	-	-	-
B-D, nearside lane	518	0.094	0.237	0.237	-	-	-	0.149	0.338	0.149	-	-	-
B-D, offside lane	518	0.094	0.237	0.237	-	-	-	0.149	0.338	0.149	-	-	-
C-B	603	0.232	0.232	0.331	-	-	-	-	-	-	-	-	-
D-A	616	-	-	-	-	-	-	0.237	-	0.094	-	-	-
D-B, nearside lane	476	0.137	0.137	0.311	-	-	-	0.217	0.217	0.086	-	-	-
D-B, offside lane	476	0.137	0.137	0.311	-	-	-	0.217	0.217	0.086	-	-	-
D-C	476	-	0.137	0.311	0.109	0.217	0.217	0.217	0.217	0.086	-	-	-

The slopes and intercepts shown above include custom intercept adjustments only.

Streams may be combined, in which case capacity will be adjusted.
 Values are shown for the first time segment only; they may differ for subsequent time segments.

Traffic Demand

Demand Set Details

ID	Scenario name	Time Period name	Traffic profile type	Start time (HH:mm)	Finish time (HH:mm)	Time segment length (min)
D1	2023	AM	ONE HOUR	08:15	09:45	15

Vehicle mix source	PCU Factor for a HV (PCU)
HV Percentages	2.00

Demand overview (Traffic)

Arm	Linked arm	Use O-D data	Average Demand (PCU/hr)	Scaling Factor (%)
A		✓	467	100.000
B		✓	154	100.000
C		✓	245	100.000
D		✓	10	100.000

Origin-Destination Data

Demand (PCU/hr)

		To			
		A	B	C	D
From	A	0	188	278	1
	B	135	0	15	4
	C	232	11	0	2
	D	2	6	2	0

Vehicle Mix

Heavy Vehicle Percentages

		To			
		A	B	C	D
From	A	0	0	2	0
	B	0	0	0	0
	C	1	0	0	0
	D	0	0	0	0

Results

Results Summary for whole modelled period

Stream	Max RFC	Max Delay (s)	Max Queue (PCU)	Max LOS
B-ACD	0.43	16.04	0.7	C
ABCD	0.00	4.53	0.0	A
A-B				
A-C				
D-ABC	0.03	9.83	0.0	A
C-ABD	0.03	5.69	0.0	A
C-D				
C-A				

Main Results for each time segment

08:15 - 08:30

Stream	Total Demand (PCU/hr)	Capacity (PCU/hr)	RFC	Throughput (PCU/hr)	End queue (PCU)	Delay (s)	Unsignalised level of service
B-ACD	116	437	0.265	115	0.4	11.123	B
A-BCD	1	801	0.002	1	0.0	4.523	A
A-B	141			141			
A-C	209			209			
D-ABC	8	416	0.018	7	0.0	8.801	A
C-ABD	11	647	0.018	11	0.0	5.682	A
C-D	1			1			
C-A	172			172			

08:30 - 08:45

Stream	Total Demand (PCU/hr)	Capacity (PCU/hr)	RFC	Throughput (PCU/hr)	End queue (PCU)	Delay (s)	Unsignalised level of service
B-ACD	138	419	0.331	138	0.5	12.793	B
A-BCD	2	842	0.002	2	0.0	4.310	A
A-B	169			169			
A-C	249			249			
D-ABC	9	400	0.022	9	0.0	9.204	A
C-ABD	15	657	0.022	15	0.0	5.620	A
C-D	2			2			
C-A	204			204			

08:45 - 09:00

Stream	Total Demand (PCU/hr)	Capacity (PCU/hr)	RFC	Throughput (PCU/hr)	End queue (PCU)	Delay (s)	Unsignalised level of service
B-ACD	170	394	0.430	169	0.7	15.903	C
A-BCD	3	899	0.003	3	0.0	4.043	A
A-B	206			206			
A-C	305			305			
D-ABC	11	377	0.029	11	0.0	9.826	A
C-ABD	20	672	0.029	20	0.0	5.536	A
C-D	2			2			
C-A	248			248			

09:00 - 09:15

Stream	Total Demand (PCU/hr)	Capacity (PCU/hr)	RFC	Throughput (PCU/hr)	End queue (PCU)	Delay (s)	Unsignalised level of service
B-ACD	170	394	0.430	170	0.7	16.038	C
A-BCD	3	899	0.003	3	0.0	4.044	A
A-B	206			206			
A-C	305			305			
D-ABC	11	377	0.029	11	0.0	9.827	A
C-ABD	20	672	0.029	20	0.0	5.538	A
C-D	2			2			
C-A	248			248			

09:15 - 09:30

Stream	Total Demand (PCU/hr)	Capacity (PCU/hr)	RFC	Throughput (PCU/hr)	End queue (PCU)	Delay (s)	Unsignalised level of service
B-ACD	138	419	0.331	139	0.5	12.930	B
A-BCD	2	842	0.002	2	0.0	4.315	A
A-B	169			169			
A-C	249			249			
D-ABC	9	400	0.022	9	0.0	9.207	A
C-ABD	15	657	0.022	15	0.0	5.627	A
C-D	2			2			
C-A	204			204			

09:30 - 09:45

Stream	Total Demand (PCU/hr)	Capacity (PCU/hr)	RFC	Throughput (PCU/hr)	End queue (PCU)	Delay (s)	Unsignalised level of service
B-ACD	116	437	0.265	116	0.4	11.262	B
A-BCD	1	801	0.002	1	0.0	4.527	A
A-B	141			141			
A-C	209			209			
D-ABC	8	416	0.018	8	0.0	8.807	A
C-ABD	11	647	0.018	11	0.0	5.686	A
C-D	1			1			
C-A	172			172			

2023, PM

Data Errors and Warnings

No errors or warnings

Junction Network

Junctions

Junction	Name	Junction type	Arm A Direction	Arm B Direction	Arm C Direction	Arm D Direction	Use circulating lanes	Junction Delay (s)	Junction LOS
1	untitled	Crossroads	Two-way	Two-way	Two-way	Two-way		5.02	A

Junction Network

Driving side	Lighting	Network delay (s)	Network LOS
Left	Normal/unknown	5.02	A

Traffic Demand

Demand Set Details

ID	Scenario name	Time Period name	Traffic profile type	Start time (HH:mm)	Finish time (HH:mm)	Time segment length (min)
D2	2023	PM	ONE HOUR	16:45	18:15	15

Vehicle mix source	PCU Factor for a HV (PCU)
HV Percentages	2.00

Demand overview (Traffic)

Arm	Linked arm	Use O-D data	Average Demand (PCU/hr)	Scaling Factor (%)
A		✓	397	100.000
B		✓	203	100.000
C		✓	345	100.000
D		✓	19	100.000

Origin-Destination Data

Demand (PCU/hr)

		To			
		A	B	C	D
From	A	0	166	228	3
	B	181	0	12	10
	C	314	16	0	15
	D	0	11	8	0

Vehicle Mix

Heavy Vehicle Percentages

		To			
		A	B	C	D
From	A	0	0	1	0
	B	0	0	0	0
	C	0	0	0	0
	D	0	0	0	0

Results

Results Summary for whole modelled period

Stream	Max RFC	Max Delay (s)	Max Queue (PCU)	Max LOS
B-ACD	0.58	21.90	1.3	C
A-BCD	0.01	4.84	0.0	A
A-B				
A-C				
D-ABC	0.06	11.48	0.1	B
C-ABD	0.04	5.23	0.1	A
C-D				
C-A				

Main Results for each time segment

16:45 - 17:00

Stream	Total Demand (PCU/hr)	Capacity (PCU/hr)	RFC	Throughput (PCU/hr)	End queue (PCU)	Delay (s)	Unsignalised level of service
B-ACD	153	431	0.355	151	0.5	12.747	B
A-BCD	4	749	0.005	4	0.0	4.841	A
A-B	124			124			
A-C	171			171			
D-ABC	14	380	0.038	14	0.0	9.845	A
C-ABD	19	708	0.026	18	0.0	5.222	A
C-D	11			11			
C-A	230			230			

17:00 - 17:15

Stream	Total Demand (PCU/hr)	Capacity (PCU/hr)	RFC	Throughput (PCU/hr)	End queue (PCU)	Delay (s)	Unsignalised level of service
B-ACD	182	413	0.442	182	0.8	15.508	C
A-BCD	5	780	0.006	5	0.0	4.658	A
A-B	148			148			
A-C	204			204			
D-ABC	17	361	0.047	17	0.0	10.474	B
C-ABD	24	730	0.033	24	0.0	5.097	A
C-D	13			13			
C-A	273			273			

17:15 - 17:30

Stream	Total Demand (PCU/hr)	Capacity (PCU/hr)	RFC	Throughput (PCU/hr)	End queue (PCU)	Delay (s)	Unsignalised level of service
B-ACD	224	387	0.577	221	1.3	21.405	C
A-BCD	7	823	0.009	7	0.0	4.422	A
A-B	181			181			
A-C	249			249			
D-ABC	21	335	0.063	21	0.1	11.469	B
C-ABD	34	763	0.044	34	0.1	4.937	A
C-D	16			16			
C-A	330			330			

17:30 - 17:45

Stream	Total Demand (PCU/hr)	Capacity (PCU/hr)	RFC	Throughput (PCU/hr)	End queue (PCU)	Delay (s)	Unsignalised level of service
B-ACD	224	387	0.577	223	1.3	21.900	C
A-BCD	7	823	0.009	7	0.0	4.425	A
A-B	181			181			
A-C	249			249			
D-ABC	21	335	0.063	21	0.1	11.478	B
C-ABD	34	763	0.044	34	0.1	4.937	A
C-D	16			16			
C-A	330			330			

17:45 - 18:00

Stream	Total Demand (PCU/hr)	Capacity (PCU/hr)	RFC	Throughput (PCU/hr)	End queue (PCU)	Delay (s)	Unsignalised level of service
B-ACD	182	413	0.442	185	0.8	15.919	C
A-BCD	5	780	0.006	5	0.0	4.660	A
A-B	148			148			
A-C	204			204			
D-ABC	17	361	0.047	17	0.1	10.485	B
C-ABD	24	730	0.033	24	0.0	5.099	A
C-D	13			13			
C-A	273			273			

18:00 - 18:15

Stream	Total Demand (PCU/hr)	Capacity (PCU/hr)	RFC	Throughput (PCU/hr)	End queue (PCU)	Delay (s)	Unsignalised level of service
B-ACD	153	431	0.355	154	0.6	13.038	B
A-BCD	4	749	0.005	4	0.0	4.842	A
A-B	124			124			
A-C	171			171			
D-ABC	14	379	0.038	14	0.0	9.861	A
C-ABD	19	708	0.026	19	0.0	5.225	A
C-D	11			11			
C-A	230			230			

2024 Bride Street Closure, AM

Data Errors and Warnings

No errors or warnings

Junction Network

Junctions

Junction	Name	Junction type	Arm A Direction	Arm B Direction	Arm C Direction	Arm D Direction	Use circulating lanes	Junction Delay (s)	Junction LOS
1	untitled	Crossroads	Two-way	Two-way	Two-way	Two-way		26.35	D

Junction Network

Driving side	Lighting	Network delay (s)	Network LOS
Left	Normal/unknown	26.35	D

Traffic Demand

Demand Set Details

ID	Scenario name	Time Period name	Traffic profile type	Start time (HH:mm)	Finish time (HH:mm)	Time segment length (min)
D3	2024 Bride Street Closure	AM	ONE HOUR	08:15	09:45	15

Vehicle mix source	PCU Factor for a HV (PCU)
HV Percentages	2.00

Demand overview (Traffic)

Arm	Linked arm	Use O-D data	Average Demand (PCU/hr)	Scaling Factor (%)
A		✓	473	100.000
B		✓	378	100.000
C		✓	0	100.000
D		✓	9	100.000

Origin-Destination Data

Demand (PCU/hr)

		To			
		A	B	C	D
From	A	0	472	0	1
	B	372	0	0	6
	C	0	0	0	0
	D	2	7	0	0

Vehicle Mix

Heavy Vehicle Percentages

		To			
		A	B	C	D
From	A	0	0	2	0
	B	0	0	0	0
	C	1	0	0	0
	D	0	0	0	0

Results

Results Summary for whole modelled period

Stream	Max RFC	Max Delay (s)	Max Queue (PCU)	Max LOS
B-ACD	0.89	59.72	6.4	F
A-BCD	0.00	4.30	0.0	A
A-B				
A-C				
D-ABC	0.02	8.40	0.0	A
C-ABD	0.00	0.00	0.0	A
C-D				
C-A				

Main Results for each time segment

08:15 - 08:30

Stream	Total Demand (PCU/hr)	Capacity (PCU/hr)	RFC	Throughput (PCU/hr)	End queue (PCU)	Delay (s)	Unsignalised level of service
B-ACD	285	483	0.589	279	1.4	17.212	C
A-BCD	1	839	0.002	1	0.0	4.295	A
A-B	355			355			
A-C	0			0			
D-ABC	7	459	0.015	7	0.0	7.962	A
C-ABD	0	520	0.000	0	0.0	0.000	A
C-D	0			0			
C-A	0			0			

08:30 - 08:45

Stream	Total Demand (PCU/hr)	Capacity (PCU/hr)	RFC	Throughput (PCU/hr)	End queue (PCU)	Delay (s)	Unsignalised level of service
B-ACD	340	476	0.713	336	2.3	24.978	C
A-BCD	2	885	0.002	2	0.0	4.074	A
A-B	423			423			
A-C	0			0			
D-ABC	8	450	0.018	8	0.0	8.140	A
C-ABD	0	504	0.000	0	0.0	0.000	A
C-D	0			0			
C-A	0			0			

08:45 - 09:00

Stream	Total Demand (PCU/hr)	Capacity (PCU/hr)	RFC	Throughput (PCU/hr)	End queue (PCU)	Delay (s)	Unsignalised level of service
B-ACD	416	467	0.891	403	5.6	48.235	E
A-BCD	2	949	0.003	2	0.0	3.804	A
A-B	518			518			
A-C	0			0			
D-ABC	10	438	0.023	10	0.0	8.401	A
C-ABD	0	482	0.000	0	0.0	0.000	A
C-D	0			0			
C-A	0			0			

09:00 - 09:15

Stream	Total Demand (PCU/hr)	Capacity (PCU/hr)	RFC	Throughput (PCU/hr)	End queue (PCU)	Delay (s)	Unsignalised level of service
B-ACD	416	467	0.891	413	6.4	59.722	F
A-BCD	2	949	0.003	2	0.0	3.807	A
A-B	518			518			
A-C	0			0			
D-ABC	10	438	0.023	10	0.0	8.401	A
C-ABD	0	482	0.000	0	0.0	0.000	A
C-D	0			0			
C-A	0			0			

09:15 - 09:30

Stream	Total Demand (PCU/hr)	Capacity (PCU/hr)	RFC	Throughput (PCU/hr)	End queue (PCU)	Delay (s)	Unsignalised level of service
B-ACD	340	476	0.713	355	2.7	32.279	D
A-BCD	2	885	0.002	2	0.0	4.074	A
A-B	423			423			
A-C	0			0			
D-ABC	8	450	0.018	8	0.0	8.143	A
C-ABD	0	504	0.000	0	0.0	0.000	A
C-D	0			0			
C-A	0			0			

09:30 - 09:45

Stream	Total Demand (PCU/hr)	Capacity (PCU/hr)	RFC	Throughput (PCU/hr)	End queue (PCU)	Delay (s)	Unsignalised level of service
B-ACD	285	483	0.589	289	1.5	19.016	C
A-BCD	1	839	0.002	1	0.0	4.295	A
A-B	355			355			
A-C	0			0			
D-ABC	7	459	0.015	7	0.0	7.965	A
C-ABD	0	520	0.000	0	0.0	0.000	A
C-D	0			0			
C-A	0			0			

2024 Bride Street Closure, PM

Data Errors and Warnings

No errors or warnings

Junction Network

Junctions

Junction	Name	Junction type	Arm A Direction	Arm B Direction	Arm C Direction	Arm D Direction	Use circulating lanes	Junction Delay (s)	Junction LOS
1	untitled	Crossroads	Two-way	Two-way	Two-way	Two-way		269.79	F

Junction Network

Driving side	Lighting	Network delay (s)	Network LOS
Left	Normal/unknown	269.79	F

Traffic Demand

Demand Set Details

ID	Scenario name	Time Period name	Traffic profile type	Start time (HH:mm)	Finish time (HH:mm)	Time segment length (min)
D4	2024 Bride Street Closure	PM	ONE HOUR	16:45	18:15	15

Vehicle mix source	PCU Factor for a HV (PCU)
HV Percentages	2.00

Demand overview (Traffic)

Arm	Linked arm	Use O-D data	Average Demand (PCU/hr)	Scaling Factor (%)
A		✓	387	100.000
B		✓	525	100.000
C		✓	0	100.000
D		✓	17	100.000

Origin-Destination Data

Demand (PCU/hr)

		To			
		A	B	C	D
From	A	0	384	0	3
	B	500	0	0	25
	C	0	0	0	0
	D	0	17	0	0

Vehicle Mix

Heavy Vehicle Percentages

		To			
		A	B	C	D
From	A	0	0	1	0
	B	0	0	0	0
	C	0	0	0	0
	D	0	0	0	0

Results

Results Summary for whole modelled period

Stream	Max RFC	Max Delay (s)	Max Queue (PCU)	Max LOS
B-ACD	1.22	477.05	63.3	F
A-BCD	0.01	4.55	0.0	A
A-B				
A-C				
D-ABC	0.04	9.02	0.0	A
C-ABD	0.00	0.00	0.0	A
C-D				
C-A				

Main Results for each time segment

16:45 - 17:00

Stream	Total Demand (PCU/hr)	Capacity (PCU/hr)	RFC	Throughput (PCU/hr)	End queue (PCU)	Delay (s)	Unsignalised level of service
B-ACD	395	488	0.810	381	3.6	30.590	D
A-BCD	4	795	0.004	4	0.0	4.547	A
A-B	288			288			
A-C	0			0			
D-ABC	13	436	0.029	13	0.0	8.498	A
C-ABD	0	535	0.000	0	0.0	0.000	A
C-D	0			0			
C-A	0			0			

17:00 - 17:15

Stream	Total Demand (PCU/hr)	Capacity (PCU/hr)	RFC	Throughput (PCU/hr)	End queue (PCU)	Delay (s)	Unsignalised level of service
B-ACD	472	482	0.980	447	9.9	71.822	F
A-BCD	5	833	0.006	5	0.0	4.348	A
A-B	343			343			
A-C	0			0			
D-ABC	15	428	0.036	15	0.0	8.713	A
C-ABD	0	522	0.000	0	0.0	0.000	A
C-D	0			0			
C-A	0			0			

17:15 - 17:30

Stream	Total Demand (PCU/hr)	Capacity (PCU/hr)	RFC	Throughput (PCU/hr)	End queue (PCU)	Delay (s)	Unsignalised level of service
B-ACD	578	474	1.220	469	37.0	199.074	F
A-BCD	6	884	0.007	6	0.0	4.101	A
A-B	420			420			
A-C	0			0			
D-ABC	19	418	0.045	19	0.0	9.023	A
C-ABD	0	504	0.000	0	0.0	0.000	A
C-D	0			0			
C-A	0			0			

17:30 - 17:45

Stream	Total Demand (PCU/hr)	Capacity (PCU/hr)	RFC	Throughput (PCU/hr)	End queue (PCU)	Delay (s)	Unsignalised level of service
B-ACD	578	474	1.220	473	63.3	394.875	F
A-BCD	6	884	0.007	6	0.0	4.102	A
A-B	420			420			
A-C	0			0			
D-ABC	19	418	0.045	19	0.0	9.024	A
C-ABD	0	504	0.000	0	0.0	0.000	A
C-D	0			0			
C-A	0			0			

17:45 - 18:00

Stream	Total Demand (PCU/hr)	Capacity (PCU/hr)	RFC	Throughput (PCU/hr)	End queue (PCU)	Delay (s)	Unsignalised level of service
B-ACD	472	482	0.980	473	63.1	477.055	F
A-BCD	5	833	0.006	5	0.0	4.349	A
A-B	343			343			
A-C	0			0			
D-ABC	15	428	0.036	15	0.0	8.717	A
C-ABD	0	522	0.000	0	0.0	0.000	A
C-D	0			0			
C-A	0			0			

18:00 - 18:15

Stream	Total Demand (PCU/hr)	Capacity (PCU/hr)	RFC	Throughput (PCU/hr)	End queue (PCU)	Delay (s)	Unsignalised level of service
B-ACD	395	488	0.810	480	41.8	395.942	F
A-BCD	4	795	0.004	4	0.0	4.549	A
A-B	288			288			
A-C	0			0			
D-ABC	13	436	0.029	13	0.0	8.504	A
C-ABD	0	535	0.000	0	0.0	0.000	A
C-D	0			0			
C-A	0			0			

2024 Market Sq Closure, AM

Data Errors and Warnings

No errors or warnings

Junction Network

Junctions

Junction	Name	Junction type	Arm A Direction	Arm B Direction	Arm C Direction	Arm D Direction	Use circulating lanes	Junction Delay (s)	Junction LOS
1	untitled	Crossroads	Two-way	Two-way	Two-way	Two-way		0.12	A

Junction Network

Driving side	Lighting	Network delay (s)	Network LOS
Left	Normal/unknown	0.12	A

Traffic Demand

Demand Set Details

ID	Scenario name	Time Period name	Traffic profile type	Start time (HH:mm)	Finish time (HH:mm)	Time segment length (min)
D5	2024 Market Sq Closure	AM	ONE HOUR	08:15	09:45	15

Vehicle mix source	PCU Factor for a HV (PCU)
HV Percentages	2.00

Demand overview (Traffic)

Arm	Linked arm	Use O-D data	Average Demand (PCU/hr)	Scaling Factor (%)
A		✓	473	100.000
B		✓	0	100.000
C		✓	378	100.000
D		✓	9	100.000

Origin-Destination Data

Demand (PCU/hr)

		To				
		A	B	C	D	
From	A	0	0	472	1	
	B	0	0	0	0	
	C	372	0	0	6	
	D	2	0	7	0	

Vehicle Mix

Heavy Vehicle Percentages

		To				
		A	B	C	D	
From	A	0	0	2	0	
	B	0	0	0	0	
	C	1	0	0	0	
	D	0	0	0	0	

Results

Results Summary for whole modelled period

Stream	Max RFC	Max Delay (s)	Max Queue (PCU)	Max LOS
B-ACD	0.00	0.00	0.0	A
A-BCD	0.00	4.63	0.0	A
A-B				
A-C				
D-ABC	0.03	10.73	0.0	B
C-ABD	0.00	0.00	0.0	A
C-D				
C-A				

Main Results for each time segment

08:15 - 08:30

Stream	Total Demand (PCU/hr)	Capacity (PCU/hr)	RFC	Throughput (PCU/hr)	End queue (PCU)	Delay (s)	Unsignalised level of service
B-ACD	0	424	0.000	0	0.0	0.000	A
A-BCD	1	786	0.002	1	0.0	4.626	A
A-B	0			0			
A-C	355			355			
D-ABC	7	396	0.017	7	0.0	9.255	A
C-ABD	0	520	0.000	0	0.0	0.000	A
C-D	5			5			
C-A	280			280			

08:30 - 08:45

Stream	Total Demand (PCU/hr)	Capacity (PCU/hr)	RFC	Throughput (PCU/hr)	End queue (PCU)	Delay (s)	Unsignalised level of service
B-ACD	0	400	0.000	0	0.0	0.000	A
A-BCD	2	825	0.002	2	0.0	4.415	A
A-B	0			0			
A-C	423			423			
D-ABC	8	375	0.022	8	0.0	9.819	A
C-ABD	0	504	0.000	0	0.0	0.000	A
C-D	5			5			
C-A	334			334			

08:45 - 09:00

Stream	Total Demand (PCU/hr)	Capacity (PCU/hr)	RFC	Throughput (PCU/hr)	End queue (PCU)	Delay (s)	Unsignalised level of service
B-ACD	0	366	0.000	0	0.0	0.000	A
A-BCD	3	880	0.003	3	0.0	4.148	A
A-B	0			0			
A-C	518			518			
D-ABC	10	345	0.029	10	0.0	10.727	B
C-ABD	0	482	0.000	0	0.0	0.000	A
C-D	7			7			
C-A	410			410			

09:00 - 09:15

Stream	Total Demand (PCU/hr)	Capacity (PCU/hr)	RFC	Throughput (PCU/hr)	End queue (PCU)	Delay (s)	Unsignalised level of service
B-ACD	0	366	0.000	0	0.0	0.000	A
A-BCD	3	880	0.003	3	0.0	4.151	A
A-B	0			0			
A-C	518			518			
D-ABC	10	345	0.029	10	0.0	10.727	B
C-ABD	0	482	0.000	0	0.0	0.000	A
C-D	7			7			
C-A	410			410			

09:15 - 09:30

Stream	Total Demand (PCU/hr)	Capacity (PCU/hr)	RFC	Throughput (PCU/hr)	End queue (PCU)	Delay (s)	Unsignalised level of service
B-ACD	0	400	0.000	0	0.0	0.000	A
A-BCD	2	825	0.002	2	0.0	4.423	A
A-B	0			0			
A-C	423			423			
D-ABC	8	375	0.022	8	0.0	9.821	A
C-ABD	0	504	0.000	0	0.0	0.000	A
C-D	5			5			
C-A	334			334			

09:30 - 09:45

Stream	Total Demand (PCU/hr)	Capacity (PCU/hr)	RFC	Throughput (PCU/hr)	End queue (PCU)	Delay (s)	Unsignalised level of service
B-ACD	0	424	0.000	0	0.0	0.000	A
A-BCD	1	786	0.002	1	0.0	4.631	A
A-B	0			0			
A-C	355			355			
D-ABC	7	396	0.017	7	0.0	9.258	A
C-ABD	0	520	0.000	0	0.0	0.000	A
C-D	5			5			
C-A	280			280			

2024 Market Sq Closure, PM

Data Errors and Warnings

No errors or warnings

Junction Network

Junctions

Junction	Name	Junction type	Arm A Direction	Arm B Direction	Arm C Direction	Arm D Direction	Use circulating lanes	Junction Delay (s)	Junction LOS
1	untitled	Crossroads	Two-way	Two-way	Two-way	Two-way		0.27	A

Junction Network

Driving side	Lighting	Network delay (s)	Network LOS
Left	Normal/unknown	0.27	A

Traffic Demand

Demand Set Details

ID	Scenario name	Time Period name	Traffic profile type	Start time (HH:mm)	Finish time (HH:mm)	Time segment length (min)
D6	2024 Market Sq Closure	PM	ONE HOUR	16:45	18:15	15

Vehicle mix source	PCU Factor for a HV (PCU)
HV Percentages	2.00

Demand overview (Traffic)

Arm	Linked arm	Use O-D data	Average Demand (PCU/hr)	Scaling Factor (%)
A		✓	387	100.000
B		✓	0	100.000
C		✓	525	100.000
D		✓	17	100.000

Origin-Destination Data

Demand (PCU/hr)

		To			
		A	B	C	D
From	A	0	0	384	3
	B	0	0	0	0
	C	500	0	0	25
	D	0	0	17	0

Vehicle Mix

Heavy Vehicle Percentages

		To			
		A	B	C	D
From	A	0	0	1	0
	B	0	0	0	0
	C	0	0	0	0
	D	0	0	0	0

Results

Results Summary for whole modelled period

Stream	Max RFC	Max Delay (s)	Max Queue (PCU)	Max LOS
B-ACD	0.00	0.00	0.0	A
A-BCD	0.01	5.06	0.0	A
A-B				
A-C				
D-ABC	0.06	13.00	0.1	B
C-ABD	0.00	0.00	0.0	A
C-D				
C-A				

Main Results for each time segment

16:45 - 17:00

Stream	Total Demand (PCU/hr)	Capacity (PCU/hr)	RFC	Throughput (PCU/hr)	End queue (PCU)	Delay (s)	Unsignalised level of service
B-ACD	0	426	0.000	0	0.0	0.000	A
A-BCD	4	718	0.005	4	0.0	5.057	A
A-B	0			0			
A-C	288			288			
D-ABC	13	353	0.036	13	0.0	10.580	B
C-ABD	0	535	0.000	0	0.0	0.000	A
C-D	19			19			
C-A	376			376			

17:00 - 17:15

Stream	Total Demand (PCU/hr)	Capacity (PCU/hr)	RFC	Throughput (PCU/hr)	End queue (PCU)	Delay (s)	Unsignalised level of service
B-ACD	0	402	0.000	0	0.0	0.000	A
A-BCD	5	744	0.007	5	0.0	4.891	A
A-B	0			0			
A-C	343			343			
D-ABC	15	329	0.046	15	0.0	11.482	B
C-ABD	0	522	0.000	0	0.0	0.000	A
C-D	22			22			
C-A	449			449			

17:15 - 17:30

Stream	Total Demand (PCU/hr)	Capacity (PCU/hr)	RFC	Throughput (PCU/hr)	End queue (PCU)	Delay (s)	Unsignalised level of service
B-ACD	0	368	0.000	0	0.0	0.000	A
A-BCD	7	782	0.009	7	0.0	4.671	A
A-B	0			0			
A-C	419			419			
D-ABC	19	296	0.063	19	0.1	12.999	B
C-ABD	0	504	0.000	0	0.0	0.000	A
C-D	28			28			
C-A	551			551			

17:30 - 17:45

Stream	Total Demand (PCU/hr)	Capacity (PCU/hr)	RFC	Throughput (PCU/hr)	End queue (PCU)	Delay (s)	Unsignalised level of service
B-ACD	0	368	0.000	0	0.0	0.000	A
A-BCD	7	782	0.009	7	0.0	4.672	A
A-B	0			0			
A-C	419			419			
D-ABC	19	296	0.063	19	0.1	13.004	B
C-ABD	0	504	0.000	0	0.0	0.000	A
C-D	28			28			
C-A	551			551			

17:45 - 18:00

Stream	Total Demand (PCU/hr)	Capacity (PCU/hr)	RFC	Throughput (PCU/hr)	End queue (PCU)	Delay (s)	Unsignalised level of service
B-ACD	0	402	0.000	0	0.0	0.000	A
A-BCD	5	744	0.007	5	0.0	4.896	A
A-B	0			0			
A-C	343			343			
D-ABC	15	329	0.046	15	0.0	11.489	B
C-ABD	0	522	0.000	0	0.0	0.000	A
C-D	22			22			
C-A	449			449			

18:00 - 18:15

Stream	Total Demand (PCU/hr)	Capacity (PCU/hr)	RFC	Throughput (PCU/hr)	End queue (PCU)	Delay (s)	Unsignalised level of service
B-ACD	0	426	0.000	0	0.0	0.000	A
A-BCD	4	718	0.005	4	0.0	5.061	A
A-B	0			0			
A-C	288			288			
D-ABC	13	353	0.036	13	0.0	10.592	B
C-ABD	0	535	0.000	0	0.0	0.000	A
C-D	19			19			
C-A	376			376			

2024 Right Turn Ban, AM

Data Errors and Warnings

No errors or warnings

Junction Network

Junctions

Junction	Name	Junction type	Arm A Direction	Arm B Direction	Arm C Direction	Arm D Direction	Use circulating lanes	Junction Delay (s)	Junction LOS
1	untitled	Crossroads	Two-way	Two-way	Two-way	Two-way		2.93	A

Junction Network

Driving side	Lighting	Network delay (s)	Network LOS
Left	Normal/unknown	2.93	A

Traffic Demand

Demand Set Details

ID	Scenario name	Time Period name	Traffic profile type	Start time (HH:mm)	Finish time (HH:mm)	Time segment length (min)
D7	2024 Right Turn Ban	AM	ONE HOUR	08:15	09:45	15

Vehicle mix source	PCU Factor for a HV (PCU)
HV Percentages	2.00

Demand overview (Traffic)

Arm	Linked arm	Use O-D data	Average Demand (PCU/hr)	Scaling Factor (%)
A		✓	467	100.000
B		✓	154	100.000
C		✓	234	100.000
D		✓	10	100.000

Origin-Destination Data

Demand (PCU/hr)

		To			
		A	B	C	D
From	A	0	188	278	1
	B	135	0	15	4
	C	232	0	0	2
	D	2	6	2	0

Vehicle Mix

Heavy Vehicle Percentages

		To			
		A	B	C	D
From	A	0	0	2	0
	B	0	0	0	0
	C	1	0	0	0
	D	0	0	0	0

Results

Results Summary for whole modelled period

Stream	Max RFC	Max Delay (s)	Max Queue (PCU)	Max LOS
B-ACD	0.43	15.76	0.7	C
A-BCD	0.00	4.51	0.0	A
A-B				
A-C				
D-ABC	0.03	9.76	0.0	A
C-ABD	0.00	0.00	0.0	A
C-D				
C-A				

Main Results for each time segment

08:15 - 08:30

Stream	Total Demand (PCU/hr)	Capacity (PCU/hr)	RFC	Throughput (PCU/hr)	End queue (PCU)	Delay (s)	Unsignalised level of service
B-ACD	116	439	0.264	115	0.4	11.033	B
A-BCD	1	803	0.002	1	0.0	4.511	A
A-B	141			141			
A-C	209			209			
D-ABC	8	418	0.018	7	0.0	8.766	A
C-ABD	0	521	0.000	0	0.0	0.000	A
C-D	2			2			
C-A	175			175			

08:30 - 08:45

Stream	Total Demand (PCU/hr)	Capacity (PCU/hr)	RFC	Throughput (PCU/hr)	End queue (PCU)	Delay (s)	Unsignalised level of service
B-ACD	138	422	0.328	138	0.5	12.650	B
A-BCD	2	844	0.002	2	0.0	4.297	A
A-B	169			169			
A-C	249			249			
D-ABC	9	402	0.022	9	0.0	9.157	A
C-ABD	0	506	0.000	0	0.0	0.000	A
C-D	2			2			
C-A	209			209			

08:45 - 09:00

Stream	Total Demand (PCU/hr)	Capacity (PCU/hr)	RFC	Throughput (PCU/hr)	End queue (PCU)	Delay (s)	Unsignalised level of service
B-ACD	170	398	0.426	169	0.7	15.634	C
A-BCD	3	901	0.003	3	0.0	4.029	A
A-B	206			206			
A-C	305			305			
D-ABC	11	380	0.029	11	0.0	9.760	A
C-ABD	0	484	0.000	0	0.0	0.000	A
C-D	2			2			
C-A	255			255			

09:00 - 09:15

Stream	Total Demand (PCU/hr)	Capacity (PCU/hr)	RFC	Throughput (PCU/hr)	End queue (PCU)	Delay (s)	Unsignalised level of service
B-ACD	170	398	0.426	170	0.7	15.759	C
A-BCD	3	901	0.003	3	0.0	4.031	A
A-B	206			206			
A-C	305			305			
D-ABC	11	380	0.029	11	0.0	9.760	A
C-ABD	0	484	0.000	0	0.0	0.000	A
C-D	2			2			
C-A	255			255			

09:15 - 09:30

Stream	Total Demand (PCU/hr)	Capacity (PCU/hr)	RFC	Throughput (PCU/hr)	End queue (PCU)	Delay (s)	Unsignalised level of service
B-ACD	138	422	0.328	139	0.5	12.779	B
A-BCD	2	844	0.002	2	0.0	4.300	A
A-B	169			169			
A-C	249			249			
D-ABC	9	402	0.022	9	0.0	9.161	A
C-ABD	0	506	0.000	0	0.0	0.000	A
C-D	2			2			
C-A	209			209			

09:30 - 09:45

Stream	Total Demand (PCU/hr)	Capacity (PCU/hr)	RFC	Throughput (PCU/hr)	End queue (PCU)	Delay (s)	Unsignalised level of service
B-ACD	116	439	0.264	116	0.4	11.165	B
A-BCD	1	803	0.002	1	0.0	4.514	A
A-B	141			141			
A-C	209			209			
D-ABC	8	418	0.018	8	0.0	8.772	A
C-ABD	0	521	0.000	0	0.0	0.000	A
C-D	2			2			
C-A	175			175			

2024 Right Turn Ban, PM

Data Errors and Warnings

No errors or warnings

Junction Network

Junctions

Junction	Name	Junction type	Arm A Direction	Arm B Direction	Arm C Direction	Arm D Direction	Use circulating lanes	Junction Delay (s)	Junction LOS
1	untitled	Crossroads	Two-way	Two-way	Two-way	Two-way		4.78	A

Junction Network

Driving side	Lighting	Network delay (s)	Network LOS
Left	Normal/unknown	4.78	A

Traffic Demand

Demand Set Details

ID	Scenario name	Time Period name	Traffic profile type	Start time (HH:mm)	Finish time (HH:mm)	Time segment length (min)
D8	2024 Right Turn Ban	PM	ONE HOUR	16:45	18:15	15

Vehicle mix source	PCU Factor for a HV (PCU)
HV Percentages	2.00

Demand overview (Traffic)

Arm	Linked arm	Use O-D data	Average Demand (PCU/hr)	Scaling Factor (%)
A		✓	397	100.000
B		✓	203	100.000
C		✓	329	100.000
D		✓	19	100.000

Origin-Destination Data

Demand (PCU/hr)

		To			
		A	B	C	D
From	A	0	166	228	3
	B	181	0	12	10
	C	314	0	0	15
	D	0	11	8	0

Vehicle Mix

Heavy Vehicle Percentages

		To			
		A	B	C	D
From	A	0	0	1	0
	B	0	0	0	0
	C	0	0	0	0
	D	0	0	0	0

Results

Results Summary for whole modelled period

Stream	Max RFC	Max Delay (s)	Max Queue (PCU)	Max LOS
B-ACD	0.57	21.15	1.3	C
A-BCD	0.01	4.82	0.0	A
A-B				
A-C				
D-ABC	0.06	11.34	0.1	B
C-ABD	0.00	0.00	0.0	A
C-D				
C-A				

Main Results for each time segment

16:45 - 17:00

Stream	Total Demand (PCU/hr)	Capacity (PCU/hr)	RFC	Throughput (PCU/hr)	End queue (PCU)	Delay (s)	Unsignalised level of service
B-ACD	153	435	0.351	151	0.5	12.573	B
A-BCD	4	752	0.005	4	0.0	4.819	A
A-B	124			124			
A-C	171			171			
D-ABC	14	382	0.037	14	0.0	9.775	A
C-ABD	0	533	0.000	0	0.0	0.000	A
C-D	11			11			
C-A	236			236			

17:00 - 17:15

Stream	Total Demand (PCU/hr)	Capacity (PCU/hr)	RFC	Throughput (PCU/hr)	End queue (PCU)	Delay (s)	Unsignalised level of service
B-ACD	182	417	0.437	182	0.8	15.198	C
A-BCD	5	783	0.006	5	0.0	4.635	A
A-B	148			148			
A-C	204			204			
D-ABC	17	364	0.047	17	0.0	10.378	B
C-ABD	0	520	0.000	0	0.0	0.000	A
C-D	13			13			
C-A	282			282			

17:15 - 17:30

Stream	Total Demand (PCU/hr)	Capacity (PCU/hr)	RFC	Throughput (PCU/hr)	End queue (PCU)	Delay (s)	Unsignalised level of service
B-ACD	224	393	0.568	222	1.3	20.708	C
A-BCD	7	828	0.008	7	0.0	4.398	A
A-B	181			181			
A-C	249			249			
D-ABC	21	339	0.062	21	0.1	11.329	B
C-ABD	0	501	0.000	0	0.0	0.000	A
C-D	17			17			
C-A	346			346			

17:30 - 17:45

Stream	Total Demand (PCU/hr)	Capacity (PCU/hr)	RFC	Throughput (PCU/hr)	End queue (PCU)	Delay (s)	Unsignalised level of service
B-ACD	224	393	0.568	223	1.3	21.147	C
A-BCD	7	828	0.008	7	0.0	4.400	A
A-B	181			181			
A-C	249			249			
D-ABC	21	338	0.062	21	0.1	11.337	B
C-ABD	0	501	0.000	0	0.0	0.000	A
C-D	17			17			
C-A	346			346			

17:45 - 18:00

Stream	Total Demand (PCU/hr)	Capacity (PCU/hr)	RFC	Throughput (PCU/hr)	End queue (PCU)	Delay (s)	Unsignalised level of service
B-ACD	182	417	0.437	184	0.8	15.572	C
A-BCD	5	783	0.006	5	0.0	4.638	A
A-B	148			148			
A-C	204			204			
D-ABC	17	364	0.047	17	0.0	10.391	B
C-ABD	0	520	0.000	0	0.0	0.000	A
C-D	13			13			
C-A	282			282			

18:00 - 18:15

Stream	Total Demand (PCU/hr)	Capacity (PCU/hr)	RFC	Throughput (PCU/hr)	End queue (PCU)	Delay (s)	Unsignalised level of service
B-ACD	153	435	0.351	154	0.6	12.849	B
A-BCD	4	752	0.005	4	0.0	4.822	A
A-B	124			124			
A-C	171			171			
D-ABC	14	382	0.037	14	0.0	9.791	A
C-ABD	0	533	0.000	0	0.0	0.000	A
C-D	11			11			
C-A	236			236			

2029 Bride Street Closure, AM

Data Errors and Warnings

No errors or warnings

Junction Network

Junctions

Junction	Name	Junction type	Arm A Direction	Arm B Direction	Arm C Direction	Arm D Direction	Use circulating lanes	Junction Delay (s)	Junction LOS
1	untitled	Crossroads	Two-way	Two-way	Two-way	Two-way		30.74	D

Junction Network

Driving side	Lighting	Network delay (s)	Network LOS
Left	Normal/unknown	30.74	D

Traffic Demand

Demand Set Details

ID	Scenario name	Time Period name	Traffic profile type	Start time (HH:mm)	Finish time (HH:mm)	Time segment length (min)
D9	2029 Bride Street Closure	AM	ONE HOUR	08:15	09:45	15

Vehicle mix source	PCU Factor for a HV (PCU)
HV Percentages	2.00

Demand overview (Traffic)

Arm	Linked arm	Use O-D data	Average Demand (PCU/hr)	Scaling Factor (%)
A		✓	488	100.000
B		✓	389	100.000
C		✓	0	100.000
D		✓	0	100.000

Origin-Destination Data

Demand (PCU/hr)

		To			
		A	B	C	D
From	A	0	487	0	1
	B	383	0	0	6
	C	0	0	0	0
	D	0	0	0	0

Vehicle Mix

Heavy Vehicle Percentages

		To			
		A	B	C	D
From	A	0	0	2	0
	B	0	0	0	0
	C	1	0	0	0
	D	0	0	0	0

Results

Results Summary for whole modelled period

Stream	Max RFC	Max Delay (s)	Max Queue (PCU)	Max LOS
B-ACD	0.92	69.27	7.7	F
A-BCD	0.00	4.26	0.0	A
A-B				
A-C				
D-ABC	0.00	0.00	0.0	A
C-ABD	0.00	0.00	0.0	A
C-D				
C-A				

Main Results for each time segment

08:15 - 08:30

Stream	Total Demand (PCU/hr)	Capacity (PCU/hr)	RFC	Throughput (PCU/hr)	End queue (PCU)	Delay (s)	Unsignalised level of service
B-ACD	293	484	0.605	287	1.5	17.816	C
A-BCD	1	847	0.002	1	0.0	4.257	A
A-B	366			366			
A-C	0			0			
D-ABC	0	467	0.000	0	0.0	0.000	A
C-ABD	0	518	0.000	0	0.0	0.000	A
C-D	0			0			
C-A	0			0			

08:30 - 08:45

Stream	Total Demand (PCU/hr)	Capacity (PCU/hr)	RFC	Throughput (PCU/hr)	End queue (PCU)	Delay (s)	Unsignalised level of service
B-ACD	350	477	0.733	346	2.5	26.511	D
A-BCD	2	894	0.002	2	0.0	4.034	A
A-B	437			437			
A-C	0			0			
D-ABC	0	459	0.000	0	0.0	0.000	A
C-ABD	0	501	0.000	0	0.0	0.000	A
C-D	0			0			
C-A	0			0			

08:45 - 09:00

Stream	Total Demand (PCU/hr)	Capacity (PCU/hr)	RFC	Throughput (PCU/hr)	End queue (PCU)	Delay (s)	Unsignalised level of service
B-ACD	428	468	0.916	412	6.4	53.545	F
A-BCD	3	960	0.003	2	0.0	3.760	A
A-B	535			535			
A-C	0			0			
D-ABC	0	448	0.000	0	0.0	0.000	A
C-ABD	0	478	0.000	0	0.0	0.000	A
C-D	0			0			
C-A	0			0			

09:00 - 09:15

Stream	Total Demand (PCU/hr)	Capacity (PCU/hr)	RFC	Throughput (PCU/hr)	End queue (PCU)	Delay (s)	Unsignalised level of service
B-ACD	428	468	0.916	423	7.7	69.270	F
A-BCD	3	960	0.003	3	0.0	3.763	A
A-B	535			535			
A-C	0			0			
D-ABC	0	448	0.000	0	0.0	0.000	A
C-ABD	0	478	0.000	0	0.0	0.000	A
C-D	0			0			
C-A	0			0			

09:15 - 09:30

Stream	Total Demand (PCU/hr)	Capacity (PCU/hr)	RFC	Throughput (PCU/hr)	End queue (PCU)	Delay (s)	Unsignalised level of service
B-ACD	350	477	0.733	368	3.0	36.982	E
A-BCD	2	894	0.002	2	0.0	4.034	A
A-B	437			437			
A-C	0			0			
D-ABC	0	458	0.000	0	0.0	0.000	A
C-ABD	0	501	0.000	0	0.0	0.000	A
C-D	0			0			
C-A	0			0			

09:30 - 09:45

Stream	Total Demand (PCU/hr)	Capacity (PCU/hr)	RFC	Throughput (PCU/hr)	End queue (PCU)	Delay (s)	Unsignalised level of service
B-ACD	293	484	0.605	299	1.6	19.996	C
A-BCD	1	847	0.002	1	0.0	4.257	A
A-B	366			366			
A-C	0			0			
D-ABC	0	466	0.000	0	0.0	0.000	A
C-ABD	0	518	0.000	0	0.0	0.000	A
C-D	0			0			
C-A	0			0			

2029 Bride Street Closure, PM

Data Errors and Warnings

No errors or warnings

Junction Network

Junctions

Junction	Name	Junction type	Arm A Direction	Arm B Direction	Arm C Direction	Arm D Direction	Use circulating lanes	Junction Delay (s)	Junction LOS
1	untitled	Crossroads	Two-way	Two-way	Two-way	Two-way		329.49	F

Junction Network

Driving side	Lighting	Network delay (s)	Network LOS
Left	Normal/unknown	329.49	F

Traffic Demand

Demand Set Details

ID	Scenario name	Time Period name	Traffic profile type	Start time (HH:mm)	Finish time (HH:mm)	Time segment length (min)
D10	2029 Bride Street Closure	PM	ONE HOUR	16:45	18:15	15

Vehicle mix source	PCU Factor for a HV (PCU)
HV Percentages	2.00

Demand overview (Traffic)

Arm	Linked arm	Use O-D data	Average Demand (PCU/hr)	Scaling Factor (%)
A		✓	399	100.000
B		✓	542	100.000
C		✓	0	100.000
D		✓	18	100.000

Origin-Destination Data

Demand (PCU/hr)

		To			
		A	B	C	D
From	A	0	396	0	3
	B	516	0	0	26
	C	0	0	0	0
	D	0	18	0	0

Vehicle Mix

Heavy Vehicle Percentages

		To			
		A	B	C	D
From	A	0	0	1	0
	B	0	0	0	0
	C	0	0	0	0
	D	0	0	0	0

Results

Results Summary for whole modelled period

Stream	Max RFC	Max Delay (s)	Max Queue (PCU)	Max LOS
B-ACD	1.26	582.64	77.7	F
A-BCD	0.01	4.51	0.0	A
A-B				
A-C				
D-ABC	0.05	9.09	0.0	A
C-ABD	0.00	0.00	0.0	A
C-D				
C-A				

Main Results for each time segment

16:45 - 17:00

Stream	Total Demand (PCU/hr)	Capacity (PCU/hr)	RFC	Throughput (PCU/hr)	End queue (PCU)	Delay (s)	Unsignalised level of service
B-ACD	408	487	0.838	392	4.1	33.619	D
A-BCD	4	801	0.004	4	0.0	4.513	A
A-B	297			297			
A-C	0			0			
D-ABC	14	435	0.031	13	0.0	8.536	A
C-ABD	0	533	0.000	0	0.0	0.000	A
C-D	0			0			
C-A	0			0			

17:00 - 17:15

Stream	Total Demand (PCU/hr)	Capacity (PCU/hr)	RFC	Throughput (PCU/hr)	End queue (PCU)	Delay (s)	Unsignalised level of service
B-ACD	487	481	1.014	454	12.4	84.536	F
A-BCD	5	840	0.006	5	0.0	4.311	A
A-B	354			354			
A-C	0			0			
D-ABC	16	427	0.038	16	0.0	8.764	A
C-ABD	0	520	0.000	0	0.0	0.000	A
C-D	0			0			
C-A	0			0			

17:15 - 17:30

Stream	Total Demand (PCU/hr)	Capacity (PCU/hr)	RFC	Throughput (PCU/hr)	End queue (PCU)	Delay (s)	Unsignalised level of service
B-ACD	597	472	1.264	469	44.2	235.318	F
A-BCD	6	893	0.007	6	0.0	4.060	A
A-B	433			433			
A-C	0			0			
D-ABC	20	416	0.048	20	0.0	9.089	A
C-ABD	0	501	0.000	0	0.0	0.000	A
C-D	0			0			
C-A	0			0			

17:30 - 17:45

Stream	Total Demand (PCU/hr)	Capacity (PCU/hr)	RFC	Throughput (PCU/hr)	End queue (PCU)	Delay (s)	Unsignalised level of service
B-ACD	597	472	1.264	472	75.5	468.081	F
A-BCD	6	893	0.007	6	0.0	4.062	A
A-B	433			433			
A-C	0			0			
D-ABC	20	416	0.048	20	0.0	9.091	A
C-ABD	0	501	0.000	0	0.0	0.000	A
C-D	0			0			
C-A	0			0			

17:45 - 18:00

Stream	Total Demand (PCU/hr)	Capacity (PCU/hr)	RFC	Throughput (PCU/hr)	End queue (PCU)	Delay (s)	Unsignalised level of service
B-ACD	487	481	1.014	479	77.7	582.644	F
A-BCD	5	840	0.006	5	0.0	4.311	A
A-B	354			354			
A-C	0			0			
D-ABC	16	427	0.038	16	0.0	8.765	A
C-ABD	0	520	0.000	0	0.0	0.000	A
C-D	0			0			
C-A	0			0			

18:00 - 18:15

Stream	Total Demand (PCU/hr)	Capacity (PCU/hr)	RFC	Throughput (PCU/hr)	End queue (PCU)	Delay (s)	Unsignalised level of service
B-ACD	408	487	0.838	481	59.6	515.649	F
A-BCD	4	801	0.005	4	0.0	4.513	A
A-B	297			297			
A-C	0			0			
D-ABC	14	435	0.031	14	0.0	8.544	A
C-ABD	0	533	0.000	0	0.0	0.000	A
C-D	0			0			
C-A	0			0			

2029 Market Sq Closure, AM

Data Errors and Warnings

No errors or warnings

Junction Network

Junctions

Junction	Name	Junction type	Arm A Direction	Arm B Direction	Arm C Direction	Arm D Direction	Use circulating lanes	Junction Delay (s)	Junction LOS
1	untitled	Crossroads	Two-way	Two-way	Two-way	Two-way		0.12	A

Junction Network

Driving side	Lighting	Network delay (s)	Network LOS
Left	Normal/unknown	0.12	A

Traffic Demand

Demand Set Details

ID	Scenario name	Time Period name	Traffic profile type	Start time (HH:mm)	Finish time (HH:mm)	Time segment length (min)
D11	2029 Market Sq Closure	AM	ONE HOUR	08:15	09:45	15

Vehicle mix source	PCU Factor for a HV (PCU)
HV Percentages	2.00

Demand overview (Traffic)

Arm	Linked arm	Use O-D data	Average Demand (PCU/hr)	Scaling Factor (%)
A		✓	488	100.000
B		✓	0	100.000
C		✓	389	100.000
D		✓	9	100.000

Origin-Destination Data

Demand (PCU/hr)

		To			
		A	B	C	D
From	A	0	0	487	1
	B	0	0	0	0
	C	383	0	0	6
	D	2	0	7	0

Vehicle Mix

Heavy Vehicle Percentages

		To			
		A	B	C	D
From	A	0	0	2	0
	B	0	0	0	0
	C	1	0	0	0
	D	0	0	0	0

Results

Results Summary for whole modelled period

Stream	Max RFC	Max Delay (s)	Max Queue (PCU)	Max LOS
B-ACD	0.00	0.00	0.0	A
A-BCD	0.00	4.59	0.0	A
A-B				
A-C				
D-ABC	0.03	10.88	0.0	B
C-ABD	0.00	0.00	0.0	A
C-D				
C-A				

Main Results for each time segment

08:15 - 08:30

Stream	Total Demand (PCU/hr)	Capacity (PCU/hr)	RFC	Throughput (PCU/hr)	End queue (PCU)	Delay (s)	Unsignalised level of service
B-ACD	0	420	0.000	0	0.0	0.000	A
A-BCD	1	793	0.002	1	0.0	4.590	A
A-B	0			0			
A-C	366			366			
D-ABC	7	392	0.017	7	0.0	9.334	A
C-ABD	0	518	0.000	0	0.0	0.000	A
C-D	5			5			
C-A	288			288			

08:30 - 08:45

Stream	Total Demand (PCU/hr)	Capacity (PCU/hr)	RFC	Throughput (PCU/hr)	End queue (PCU)	Delay (s)	Unsignalised level of service
B-ACD	0	395	0.000	0	0.0	0.000	A
A-BCD	2	833	0.002	2	0.0	4.375	A
A-B	0			0			
A-C	437			437			
D-ABC	8	371	0.022	8	0.0	9.926	A
C-ABD	0	501	0.000	0	0.0	0.000	A
C-D	5			5			
C-A	344			344			

08:45 - 09:00

Stream	Total Demand (PCU/hr)	Capacity (PCU/hr)	RFC	Throughput (PCU/hr)	End queue (PCU)	Delay (s)	Unsignalised level of service
B-ACD	0	361	0.000	0	0.0	0.000	A
A-BCD	3	890	0.003	3	0.0	4.103	A
A-B	0			0			
A-C	535			535			
D-ABC	10	341	0.029	10	0.0	10.884	B
C-ABD	0	478	0.000	0	0.0	0.000	A
C-D	7			7			
C-A	422			422			

09:00 - 09:15

Stream	Total Demand (PCU/hr)	Capacity (PCU/hr)	RFC	Throughput (PCU/hr)	End queue (PCU)	Delay (s)	Unsignalised level of service
B-ACD	0	361	0.000	0	0.0	0.000	A
A-BCD	3	890	0.003	3	0.0	4.108	A
A-B	0			0			
A-C	535			535			
D-ABC	10	341	0.029	10	0.0	10.884	B
C-ABD	0	478	0.000	0	0.0	0.000	A
C-D	7			7			
C-A	422			422			

09:15 - 09:30

Stream	Total Demand (PCU/hr)	Capacity (PCU/hr)	RFC	Throughput (PCU/hr)	End queue (PCU)	Delay (s)	Unsignalised level of service
B-ACD	0	395	0.000	0	0.0	0.000	A
A-BCD	2	833	0.002	2	0.0	4.381	A
A-B	0			0			
A-C	437			437			
D-ABC	8	371	0.022	8	0.0	9.927	A
C-ABD	0	501	0.000	0	0.0	0.000	A
C-D	5			5			
C-A	344			344			

09:30 - 09:45

Stream	Total Demand (PCU/hr)	Capacity (PCU/hr)	RFC	Throughput (PCU/hr)	End queue (PCU)	Delay (s)	Unsignalised level of service
B-ACD	0	420	0.000	0	0.0	0.000	A
A-BCD	1	793	0.002	1	0.0	4.593	A
A-B	0			0			
A-C	366			366			
D-ABC	7	392	0.017	7	0.0	9.338	A
C-ABD	0	518	0.000	0	0.0	0.000	A
C-D	5			5			
C-A	288			288			

2029 Market Sq Closure, PM

Data Errors and Warnings

Severity	Area	Item	Description
Warning	Vehicle Mix		HV% is zero for all movements / time segments. Vehicle Mix matrix should be completed whether working in PCUs or Vehs. If HV% at the junction is genuinely zero, please ignore this warning.

Junction Network

Junctions

Junction	Name	Junction type	Arm A Direction	Arm B Direction	Arm C Direction	Arm D Direction	Use circulating lanes	Junction Delay (s)	Junction LOS
1	untitled	Crossroads	Two-way	Two-way	Two-way	Two-way		0.28	A

Junction Network

Driving side	Lighting	Network delay (s)	Network LOS
Left	Normal/unknown	0.28	A

Traffic Demand

Demand Set Details

ID	Scenario name	Time Period name	Traffic profile type	Start time (HH:mm)	Finish time (HH:mm)	Time segment length (min)
D12	2029 Market Sq Closure	PM	ONE HOUR	16:45	18:15	15

Vehicle mix source	PCU Factor for a HV (PCU)
HV Percentages	2.00

Demand overview (Traffic)

Arm	Linked arm	Use O-D data	Average Demand (PCU/hr)	Scaling Factor (%)
A		✓	399	100.000
B		✓	0	100.000
C		✓	542	100.000
D		✓	18	100.000

Origin-Destination Data

Demand (PCU/hr)

	To				
	A	B	C	D	
From	A	0	0	396	3
	B	0	0	0	0
	C	516	0	0	26
	D	0	0	18	0

Vehicle Mix

Heavy Vehicle Percentages

	To				
	A	B	C	D	
From	A	0	0	0	0
	B	0	0	0	0
	C	0	0	0	0
	D	0	0	0	0

Results

Results Summary for whole modelled period

Stream	Max RFC	Max Delay (s)	Max Queue (PCU)	Max LOS
B-ACD	0.00	0.00	0.0	A
A-BCD	0.01	5.01	0.0	A
A-B				
A-C				
D-ABC	0.07	13.33	0.1	B
C-ABD	0.00	0.00	0.0	A
C-D				
C-A				

Main Results for each time segment

16:45 - 17:00

Stream	Total Demand (PCU/hr)	Capacity (PCU/hr)	RFC	Throughput (PCU/hr)	End queue (PCU)	Delay (s)	Unsignalised level of service
B-ACD	0	422	0.000	0	0.0	0.000	A
A-BCD	4	722	0.005	4	0.0	5.009	A
A-B	0			0			
A-C	297			297			
D-ABC	14	349	0.039	13	0.0	10.728	B
C-ABD	0	533	0.000	0	0.0	0.000	A
C-D	20			20			
C-A	388			388			

17:00 - 17:15

Stream	Total Demand (PCU/hr)	Capacity (PCU/hr)	RFC	Throughput (PCU/hr)	End queue (PCU)	Delay (s)	Unsignalised level of service
B-ACD	0	397	0.000	0	0.0	0.000	A
A-BCD	5	749	0.007	5	0.0	4.838	A
A-B	0			0			
A-C	354			354			
D-ABC	16	324	0.050	16	0.1	11.690	B
C-ABD	0	520	0.000	0	0.0	0.000	A
C-D	23			23			
C-A	464			464			

17:15 - 17:30

Stream	Total Demand (PCU/hr)	Capacity (PCU/hr)	RFC	Throughput (PCU/hr)	End queue (PCU)	Delay (s)	Unsignalised level of service
B-ACD	0	363	0.000	0	0.0	0.000	A
A-BCD	7	788	0.009	7	0.0	4.610	A
A-B	0			0			
A-C	432			432			
D-ABC	20	290	0.068	20	0.1	13.325	B
C-ABD	0	501	0.000	0	0.0	0.000	A
C-D	29			29			
C-A	568			568			

17:30 - 17:45

Stream	Total Demand (PCU/hr)	Capacity (PCU/hr)	RFC	Throughput (PCU/hr)	End queue (PCU)	Delay (s)	Unsignalised level of service
B-ACD	0	363	0.000	0	0.0	0.000	A
A-BCD	7	788	0.009	7	0.0	4.610	A
A-B	0			0			
A-C	432			432			
D-ABC	20	290	0.068	20	0.1	13.333	B
C-ABD	0	501	0.000	0	0.0	0.000	A
C-D	29			29			
C-A	568			568			

17:45 - 18:00

Stream	Total Demand (PCU/hr)	Capacity (PCU/hr)	RFC	Throughput (PCU/hr)	End queue (PCU)	Delay (s)	Unsignalised level of service
B-ACD	0	397	0.000	0	0.0	0.000	A
A-BCD	5	749	0.007	5	0.0	4.840	A
A-B	0			0			
A-C	354			354			
D-ABC	16	324	0.050	16	0.1	11.698	B
C-ABD	0	520	0.000	0	0.0	0.000	A
C-D	23			23			
C-A	464			464			

18:00 - 18:15

Stream	Total Demand (PCU/hr)	Capacity (PCU/hr)	RFC	Throughput (PCU/hr)	End queue (PCU)	Delay (s)	Unsignalised level of service
B-ACD	0	422	0.000	0	0.0	0.000	A
A-BCD	4	722	0.005	4	0.0	5.012	A
A-B	0			0			
A-C	297			297			
D-ABC	14	349	0.039	14	0.0	10.740	B
C-ABD	0	533	0.000	0	0.0	0.000	A
C-D	20			20			
C-A	388			388			

2039 Bride Street Closure, AM

Data Errors and Warnings

No errors or warnings

Junction Network

Junctions

Junction	Name	Junction type	Arm A Direction	Arm B Direction	Arm C Direction	Arm D Direction	Use circulating lanes	Junction Delay (s)	Junction LOS
1	untitled	Crossroads	Two-way	Two-way	Two-way	Two-way		43.96	E

Junction Network

Driving side	Lighting	Network delay (s)	Network LOS
Left	Normal/unknown	43.96	E

Traffic Demand

Demand Set Details

ID	Scenario name	Time Period name	Traffic profile type	Start time (HH:mm)	Finish time (HH:mm)	Time segment length (min)
D13	2039 Bride Street Closure	AM	ONE HOUR	08:15	09:45	15

Vehicle mix source	PCU Factor for a HV (PCU)
HV Percentages	2.00

Demand overview (Traffic)

Arm	Linked arm	Use O-D data	Average Demand (PCU/hr)	Scaling Factor (%)
A		✓	511	100.000
B		✓	408	100.000
C		✓	0	100.000
D		✓	10	100.000

Origin-Destination Data

Demand (PCU/hr)

		To			
		A	B	C	D
From	A	0	510	0	1
	B	401	0	0	7
	C	0	0	0	0
	D	2	8	0	0

Vehicle Mix

Heavy Vehicle Percentages

		To			
		A	B	C	D
From	A	0	0	2	0
	B	0	0	0	0
	C	1	0	0	0
	D	0	0	0	0

Results

Results Summary for whole modelled period

Stream	Max RFC	Max Delay (s)	Max Queue (PCU)	Max LOS
B-ACD	0.97	99.86	11.9	F
A-BCD	0.00	4.20	0.0	A
A-B				
A-C				
D-ABC	0.03	8.60	0.0	A
C-ABD	0.00	0.00	0.0	A
C-D				
C-A				

Main Results for each time segment

08:15 - 08:30

Stream	Total Demand (PCU/hr)	Capacity (PCU/hr)	RFC	Throughput (PCU/hr)	End queue (PCU)	Delay (s)	Unsignalised level of service
B-ACD	307	480	0.639	300	1.7	19.363	C
A-BCD	1	858	0.002	1	0.0	4.200	A
A-B	383			383			
A-C	0			0			
D-ABC	8	452	0.017	7	0.0	8.098	A
C-ABD	0	514	0.000	0	0.0	0.000	A
C-D	0			0			
C-A	0			0			

08:30 - 08:45

Stream	Total Demand (PCU/hr)	Capacity (PCU/hr)	RFC	Throughput (PCU/hr)	End queue (PCU)	Delay (s)	Unsignalised level of service
B-ACD	367	473	0.775	361	3.0	30.723	D
A-BCD	2	908	0.002	2	0.0	3.973	A
A-B	458			458			
A-C	0			0			
D-ABC	9	443	0.020	9	0.0	8.302	A
C-ABD	0	496	0.000	0	0.0	0.000	A
C-D	0			0			
C-A	0			0			

08:45 - 09:00

Stream	Total Demand (PCU/hr)	Capacity (PCU/hr)	RFC	Throughput (PCU/hr)	End queue (PCU)	Delay (s)	Unsignalised level of service
B-ACD	449	463	0.971	425	9.1	68.890	F
A-BCD	3	976	0.003	3	0.0	3.696	A
A-B	560			560			
A-C	0			0			
D-ABC	11	430	0.026	11	0.0	8.601	A
C-ABD	0	473	0.000	0	0.0	0.000	A
C-D	0			0			
C-A	0			0			

09:00 - 09:15

Stream	Total Demand (PCU/hr)	Capacity (PCU/hr)	RFC	Throughput (PCU/hr)	End queue (PCU)	Delay (s)	Unsignalised level of service
B-ACD	449	463	0.971	438	11.9	99.858	F
A-BCD	3	976	0.003	3	0.0	3.696	A
A-B	560			560			
A-C	0			0			
D-ABC	11	430	0.026	11	0.0	8.601	A
C-ABD	0	473	0.000	0	0.0	0.000	A
C-D	0			0			
C-A	0			0			

09:15 - 09:30

Stream	Total Demand (PCU/hr)	Capacity (PCU/hr)	RFC	Throughput (PCU/hr)	End queue (PCU)	Delay (s)	Unsignalised level of service
B-ACD	367	473	0.775	398	4.0	56.922	F
A-BCD	2	908	0.002	2	0.0	3.974	A
A-B	458			458			
A-C	0			0			
D-ABC	9	443	0.020	9	0.0	8.304	A
C-ABD	0	496	0.000	0	0.0	0.000	A
C-D	0			0			
C-A	0			0			

09:30 - 09:45

Stream	Total Demand (PCU/hr)	Capacity (PCU/hr)	RFC	Throughput (PCU/hr)	End queue (PCU)	Delay (s)	Unsignalised level of service
B-ACD	307	480	0.639	316	1.9	22.879	C
A-BCD	1	858	0.002	1	0.0	4.202	A
A-B	383			383			
A-C	0			0			
D-ABC	8	452	0.017	8	0.0	8.101	A
C-ABD	0	514	0.000	0	0.0	0.000	A
C-D	0			0			
C-A	0			0			

2039 Bride Street Closure, PM

Data Errors and Warnings

No errors or warnings

Junction Network

Junctions

Junction	Name	Junction type	Arm A Direction	Arm B Direction	Arm C Direction	Arm D Direction	Use circulating lanes	Junction Delay (s)	Junction LOS
1	untitled	Crossroads	Two-way	Two-way	Two-way	Two-way		423.08	F

Junction Network

Driving side	Lighting	Network delay (s)	Network LOS
Left	Normal/unknown	423.08	F

Traffic Demand

Demand Set Details

ID	Scenario name	Time Period name	Traffic profile type	Start time (HH:mm)	Finish time (HH:mm)	Time segment length (min)
D14	2039 Bride Street Closure	PM	ONE HOUR	16:45	18:15	15

Vehicle mix source	PCU Factor for a HV (PCU)
HV Percentages	2.00

Demand overview (Traffic)

Arm	Linked arm	Use O-D data	Average Demand (PCU/hr)	Scaling Factor (%)
A		✓	418	100.000
B		✓	567	100.000
C		✓	0	100.000
D		✓	19	100.000

Origin-Destination Data

Demand (PCU/hr)

		To			
		A	B	C	D
From	A	0	415	0	3
	B	540	0	0	27
	C	0	0	0	0
	D	0	19	0	0

Vehicle Mix

Heavy Vehicle Percentages

		To			
		A	B	C	D
From	A	0	0	1	0
	B	0	0	0	0
	C	0	0	0	0
	D	0	0	0	0

Results

Results Summary for whole modelled period

Stream	Max RFC	Max Delay (s)	Max Queue (PCU)	Max LOS
B-ACD	1.33	748.81	102.6	F
A-BCD	0.01	4.46	0.0	A
A-B				
A-C				
D-ABC	0.05	9.18	0.1	A
C-ABD	0.00	0.00	0.0	A
C-D				
C-A				

Main Results for each time segment

16:45 - 17:00

Stream	Total Demand (PCU/hr)	Capacity (PCU/hr)	RFC	Throughput (PCU/hr)	End queue (PCU)	Delay (s)	Unsignalised level of service
B-ACD	427	485	0.880	406	5.1	38.960	E
A-BCD	4	811	0.005	4	0.0	4.460	A
A-B	311			311			
A-C	0			0			
D-ABC	14	433	0.033	14	0.0	8.592	A
C-ABD	0	530	0.000	0	0.0	0.000	A
C-D	0			0			
C-A	0			0			

17:00 - 17:15

Stream	Total Demand (PCU/hr)	Capacity (PCU/hr)	RFC	Throughput (PCU/hr)	End queue (PCU)	Delay (s)	Unsignalised level of service
B-ACD	510	479	1.065	462	17.1	107.094	F
A-BCD	5	851	0.006	5	0.0	4.253	A
A-B	371			371			
A-C	0			0			
D-ABC	17	425	0.040	17	0.0	8.833	A
C-ABD	0	516	0.000	0	0.0	0.000	A
C-D	0			0			
C-A	0			0			

17:15 - 17:30

Stream	Total Demand (PCU/hr)	Capacity (PCU/hr)	RFC	Throughput (PCU/hr)	End queue (PCU)	Delay (s)	Unsignalised level of service
B-ACD	624	470	1.328	468	56.0	297.737	F
A-BCD	7	907	0.007	7	0.0	3.999	A
A-B	454			454			
A-C	0			0			
D-ABC	21	413	0.051	21	0.1	9.181	A
C-ABD	0	496	0.000	0	0.0	0.000	A
C-D	0			0			
C-A	0			0			

17:30 - 17:45

Stream	Total Demand (PCU/hr)	Capacity (PCU/hr)	RFC	Throughput (PCU/hr)	End queue (PCU)	Delay (s)	Unsignalised level of service
B-ACD	624	470	1.328	470	94.7	586.255	F
A-BCD	7	907	0.007	7	0.0	3.999	A
A-B	454			454			
A-C	0			0			
D-ABC	21	413	0.051	21	0.1	9.182	A
C-ABD	0	496	0.000	0	0.0	0.000	A
C-D	0			0			
C-A	0			0			

17:45 - 18:00

Stream	Total Demand (PCU/hr)	Capacity (PCU/hr)	RFC	Throughput (PCU/hr)	End queue (PCU)	Delay (s)	Unsignalised level of service
B-ACD	510	479	1.065	478	102.6	748.810	F
A-BCD	5	851	0.006	5	0.0	4.255	A
A-B	371			371			
A-C	0			0			
D-ABC	17	425	0.040	17	0.0	8.837	A
C-ABD	0	516	0.000	0	0.0	0.000	A
C-D	0			0			
C-A	0			0			

18:00 - 18:15

Stream	Total Demand (PCU/hr)	Capacity (PCU/hr)	RFC	Throughput (PCU/hr)	End queue (PCU)	Delay (s)	Unsignalised level of service
B-ACD	427	485	0.880	481	89.2	718.964	F
A-BCD	4	811	0.005	4	0.0	4.460	A
A-B	311			311			
A-C	0			0			
D-ABC	14	433	0.033	14	0.0	8.598	A
C-ABD	0	530	0.000	0	0.0	0.000	A
C-D	0			0			
C-A	0			0			

2039 Market Sq Closure, AM

Data Errors and Warnings

No errors or warnings

Junction Network

Junctions

Junction	Name	Junction type	Arm A Direction	Arm B Direction	Arm C Direction	Arm D Direction	Use circulating lanes	Junction Delay (s)	Junction LOS
1	untitled	Crossroads	Two-way	Two-way	Two-way	Two-way		0.13	A

Junction Network

Driving side	Lighting	Network delay (s)	Network LOS
Left	Normal/unknown	0.13	A

Traffic Demand

Demand Set Details

ID	Scenario name	Time Period name	Traffic profile type	Start time (HH:mm)	Finish time (HH:mm)	Time segment length (min)
D15	2039 Market Sq Closure	AM	ONE HOUR	08:15	09:45	15

Vehicle mix source	PCU Factor for a HV (PCU)
HV Percentages	2.00

Demand overview (Traffic)

Arm	Linked arm	Use O-D data	Average Demand (PCU/hr)	Scaling Factor (%)
A		✓	511	100.000
B		✓	0	100.000
C		✓	408	100.000
D		✓	10	100.000

Origin-Destination Data

Demand (PCU/hr)

		To			
		A	B	C	D
From	A	0	0	510	1
	B	0	0	0	0
	C	401	0	0	7
	D	2	0	8	0

Vehicle Mix

Heavy Vehicle Percentages

		To			
		A	B	C	D
From	A	0	0	2	0
	B	0	0	0	0
	C	1	0	0	0
	D	0	0	0	0

Results

Results Summary for whole modelled period

Stream	Max RFC	Max Delay (s)	Max Queue (PCU)	Max LOS
B-ACD	0.00	0.00	0.0	A
A-BCD	0.00	4.54	0.0	A
A-B				
A-C				
D-ABC	0.03	11.30	0.0	B
C-ABD	0.00	0.00	0.0	A
C-D				
C-A				

Main Results for each time segment

08:15 - 08:30

Stream	Total Demand (PCU/hr)	Capacity (PCU/hr)	RFC	Throughput (PCU/hr)	End queue (PCU)	Delay (s)	Unsignalised level of service
B-ACD	0	414	0.000	0	0.0	0.000	A
A-BCD	1	802	0.002	1	0.0	4.537	A
A-B	0			0			
A-C	383			383			
D-ABC	8	384	0.020	7	0.0	9.559	A
C-ABD	0	514	0.000	0	0.0	0.000	A
C-D	5			5			
C-A	302			302			

08:30 - 08:45

Stream	Total Demand (PCU/hr)	Capacity (PCU/hr)	RFC	Throughput (PCU/hr)	End queue (PCU)	Delay (s)	Unsignalised level of service
B-ACD	0	388	0.000	0	0.0	0.000	A
A-BCD	2	845	0.002	2	0.0	4.316	A
A-B	0			0			
A-C	457			457			
D-ABC	9	361	0.025	9	0.0	10.220	B
C-ABD	0	496	0.000	0	0.0	0.000	A
C-D	6			6			
C-A	360			360			

08:45 - 09:00

Stream	Total Demand (PCU/hr)	Capacity (PCU/hr)	RFC	Throughput (PCU/hr)	End queue (PCU)	Delay (s)	Unsignalised level of service
B-ACD	0	352	0.000	0	0.0	0.000	A
A-BCD	3	905	0.003	3	0.0	4.038	A
A-B	0			0			
A-C	560			560			
D-ABC	11	330	0.033	11	0.0	11.300	B
C-ABD	0	473	0.000	0	0.0	0.000	A
C-D	8			8			
C-A	442			442			

09:00 - 09:15

Stream	Total Demand (PCU/hr)	Capacity (PCU/hr)	RFC	Throughput (PCU/hr)	End queue (PCU)	Delay (s)	Unsignalised level of service
B-ACD	0	352	0.000	0	0.0	0.000	A
A-BCD	3	905	0.003	3	0.0	4.042	A
A-B	0			0			
A-C	560			560			
D-ABC	11	330	0.033	11	0.0	11.302	B
C-ABD	0	473	0.000	0	0.0	0.000	A
C-D	8			8			
C-A	442			442			

09:15 - 09:30

Stream	Total Demand (PCU/hr)	Capacity (PCU/hr)	RFC	Throughput (PCU/hr)	End queue (PCU)	Delay (s)	Unsignalised level of service
B-ACD	0	388	0.000	0	0.0	0.000	A
A-BCD	2	845	0.002	2	0.0	4.322	A
A-B	0			0			
A-C	457			457			
D-ABC	9	361	0.025	9	0.0	10.224	B
C-ABD	0	496	0.000	0	0.0	0.000	A
C-D	6			6			
C-A	360			360			

09:30 - 09:45

Stream	Total Demand (PCU/hr)	Capacity (PCU/hr)	RFC	Throughput (PCU/hr)	End queue (PCU)	Delay (s)	Unsignalised level of service
B-ACD	0	414	0.000	0	0.0	0.000	A
A-BCD	1	802	0.002	1	0.0	4.542	A
A-B	0			0			
A-C	383			383			
D-ABC	8	384	0.020	8	0.0	9.566	A
C-ABD	0	514	0.000	0	0.0	0.000	A
C-D	5			5			
C-A	302			302			

2039 Market Sq Closure, PM

Data Errors and Warnings

No errors or warnings

Junction Network

Junctions

Junction	Name	Junction type	Arm A Direction	Arm B Direction	Arm C Direction	Arm D Direction	Use circulating lanes	Junction Delay (s)	Junction LOS
1	untitled	Crossroads	Two-way	Two-way	Two-way	Two-way		0.29	A

Junction Network

Driving side	Lighting	Network delay (s)	Network LOS
Left	Normal/unknown	0.29	A

Traffic Demand

Demand Set Details

ID	Scenario name	Time Period name	Traffic profile type	Start time (HH:mm)	Finish time (HH:mm)	Time segment length (min)
D16	2039 Market Sq Closure	PM	ONE HOUR	16:45	18:15	15

Vehicle mix source	PCU Factor for a HV (PCU)
HV Percentages	2.00

Demand overview (Traffic)

Arm	Linked arm	Use O-D data	Average Demand (PCU/hr)	Scaling Factor (%)
A		✓	418	100.000
B		✓	0	100.000
C		✓	567	100.000
D		✓	19	100.000

Origin-Destination Data

Demand (PCU/hr)

		To			
		A	B	C	D
From	A	0	0	415	3
	B	0	0	0	0
	C	540	0	0	27
	D	0	0	19	0

Vehicle Mix

Heavy Vehicle Percentages

		To			
		A	B	C	D
From	A	0	0	1	0
	B	0	0	0	0
	C	0	0	0	0
	D	0	0	0	0

Results

Results Summary for whole modelled period

Stream	Max RFC	Max Delay (s)	Max Queue (PCU)	Max LOS
B-ACD	0.00	0.00	0.0	A
A-BCD	0.01	4.99	0.0	A
A-B				
A-C				
D-ABC	0.07	13.84	0.1	B
C-ABD	0.00	0.00	0.0	A
C-D				
C-A				

Main Results for each time segment

16:45 - 17:00

Stream	Total Demand (PCU/hr)	Capacity (PCU/hr)	RFC	Throughput (PCU/hr)	End queue (PCU)	Delay (s)	Unsignalised level of service
B-ACD	0	416	0.000	0	0.0	0.000	A
A-BCD	4	729	0.005	4	0.0	4.985	A
A-B	0			0			
A-C	311			311			
D-ABC	14	343	0.042	14	0.0	10.945	B
C-ABD	0	530	0.000	0	0.0	0.000	A
C-D	20			20			
C-A	407			407			

17:00 - 17:15

Stream	Total Demand (PCU/hr)	Capacity (PCU/hr)	RFC	Throughput (PCU/hr)	End queue (PCU)	Delay (s)	Unsignalised level of service
B-ACD	0	390	0.000	0	0.0	0.000	A
A-BCD	5	757	0.007	5	0.0	4.808	A
A-B	0			0			
A-C	370			370			
D-ABC	17	317	0.054	17	0.1	12.002	B
C-ABD	0	516	0.000	0	0.0	0.000	A
C-D	24			24			
C-A	485			485			

17:15 - 17:30

Stream	Total Demand (PCU/hr)	Capacity (PCU/hr)	RFC	Throughput (PCU/hr)	End queue (PCU)	Delay (s)	Unsignalised level of service
B-ACD	0	354	0.000	0	0.0	0.000	A
A-BCD	8	799	0.010	8	0.0	4.574	A
A-B	0			0			
A-C	452			452			
D-ABC	21	281	0.074	21	0.1	13.827	B
C-ABD	0	496	0.000	0	0.0	0.000	A
C-D	30			30			
C-A	595			595			

17:30 - 17:45

Stream	Total Demand (PCU/hr)	Capacity (PCU/hr)	RFC	Throughput (PCU/hr)	End queue (PCU)	Delay (s)	Unsignalised level of service
B-ACD	0	354	0.000	0	0.0	0.000	A
A-BCD	8	799	0.010	8	0.0	4.577	A
A-B	0			0			
A-C	452			452			
D-ABC	21	281	0.074	21	0.1	13.836	B
C-ABD	0	496	0.000	0	0.0	0.000	A
C-D	30			30			
C-A	595			595			

17:45 - 18:00

Stream	Total Demand (PCU/hr)	Capacity (PCU/hr)	RFC	Throughput (PCU/hr)	End queue (PCU)	Delay (s)	Unsignalised level of service
B-ACD	0	390	0.000	0	0.0	0.000	A
A-BCD	5	757	0.007	5	0.0	4.813	A
A-B	0			0			
A-C	370			370			
D-ABC	17	317	0.054	17	0.1	12.014	B
C-ABD	0	516	0.000	0	0.0	0.000	A
C-D	24			24			
C-A	485			485			

18:00 - 18:15

Stream	Total Demand (PCU/hr)	Capacity (PCU/hr)	RFC	Throughput (PCU/hr)	End queue (PCU)	Delay (s)	Unsignalised level of service
B-ACD	0	416	0.000	0	0.0	0.000	A
A-BCD	4	729	0.005	4	0.0	4.987	A
A-B	0			0			
A-C	311			311			
D-ABC	14	343	0.042	14	0.0	10.961	B
C-ABD	0	530	0.000	0	0.0	0.000	A
C-D	20			20			
C-A	407			407			

Junctions 10
PICADY 10 - Priority Intersection Module
Version: 10.0.4.1693 © Copyright TRL Software Limited, 2021
For sales and distribution information, program advice and maintenance, contact TRL Software: +44 (0)1344 379777 software@trl.co.uk trlsoftware.com
The users of this computer program for the solution of an engineering problem are in no way relieved of their responsibility for the correctness of the solution

Filename: R445 _ Market Square Base Model 2.j10
Path: \\na.aecomnet.com\lfs\EMEA\Dublin-IEDBL1\Legacy\IEDBL1FP001\UFI\Jobs\PR-384133_Kildare-Newbridge-Town\400_Technical\404_CE\01_Traffic\05_Reports\03_TTA KMS\Flow Diagram and Modelling\Models
Report generation date: 20/12/2023 10:51:44

«2021 Base, AM

- »Junction Network
- »Arms
- »Traffic Demand
- »Origin-Destination Data
- »Vehicle Mix
- »Results

Summary of junction performance

	AM					PM				
	Set ID	Queue (PCU)	Delay (s)	RFC	LOS	Set ID	Queue (PCU)	Delay (s)	RFC	LOS
2021 Base										
Stream B-C	D1	0.4	7.17	0.30	A	D2	0.4	6.77	0.26	A
Stream B-A		0.0	8.96	0.04	A		0.1	9.56	0.06	A
Stream C-AB		0.6	7.31	0.31	A		1.2	8.04	0.45	A

There are warnings associated with one or more model runs - see the 'Data Errors and Warnings' tables for each Analysis or Demand Set.

Values shown are the highest values encountered over all time segments. Delay is the maximum value of average delay per arriving vehicle.

File summary

File Description

Title	
Location	
Site number	
Date	20/12/2023
Version	
Status	(new file)
Identifier	
Client	
Jobnumber	
Enumerator	NA\SimmonsA1
Description	

Units

Distance units	Speed units	Traffic units input	Traffic units results	Flow units	Average delay units	Total delay units	Rate of delay units
m	kph	PCU	PCU	perHour	s	-Min	perMin

Analysis Options

Calculate Queue Percentiles	Calculate residual capacity	RFC Threshold	Average Delay threshold (s)	Queue threshold (PCU)
		0.85	36.00	20.00

Analysis Set Details

ID	Network flow scaling factor (%)
A1	100.000

Demand Set Details

ID	Scenario name	Time Period name	Traffic profile type	Start time (HH:mm)	Finish time (HH:mm)	Time segment length (min)
D1	2021 Base	AM	ONE HOUR	08:15	09:45	15

2021 Base, AM

Data Errors and Warnings

Severity	Area	Item	Description
Warning	Minor arm visibility to right	Arm B - Minor arm geometry	Visibility to right expected to have two components if the arm has two lanes, or two lanes in a flared section.

Junction Network

Junctions

Junction	Name	Junction type	Arm A Direction	Arm B Direction	Arm C Direction	Use circulating lanes	Junction Delay (s)	Junction LOS
1	untitled	T-Junction	Two-way	Two-way	Two-way		3.57	A

Junction Network

Driving side	Lighting	Network delay (s)	Network LOS
Left	Normal/unknown	3.57	A

Arms

Arms

Arm	Name	Description	Arm type
A	R445 (W)		Major
B	Market Square		Minor
C	R445 (E)		Major

Major Arm Geometry

Arm	Width of carriageway (m)	Has kerbed central reserve	Has right-turn storage	Visibility for right turn (m)	Blocks?	Blocking queue (PCU)
C	13.85			85.0	✓	0.00

Geometries for Arm C are measured opposite Arm B. Geometries for Arm A (if relevant) are measured opposite Arm D.

Minor Arm Geometry

Arm	Minor arm type	Width at give-way (m)	Width at 5m (m)	Width at 10m (m)	Width at 15m (m)	Width at 20m (m)	Estimate flare length	Flare length (PCU)	Visibility to left (m)	Visibility to right (m)
B	One lane plus flare	10.00	9.61	7.31	6.64	6.18		3.00	80	43

Slope / Intercept / Capacity

Priority Intersection Slopes and Intercepts

Stream	Intercept (PCU/hr)	Slope for A-B	Slope for A-C	Slope for C-A	Slope for C-B
B-A	522	0.063	0.158	0.100	0.226
B-C	781	0.079	0.199	-	-
C-B	623	0.159	0.159	-	-

The slopes and intercepts shown above include custom intercept adjustments only.

Streams may be combined, in which case capacity will be adjusted.

Values are shown for the first time segment only; they may differ for subsequent time segments.

Traffic Demand

Vehicle mix source	PCU Factor for a HV (PCU)
HV Percentages	2.00

Demand overview (Traffic)

Arm	Linked arm	Use O-D data	Average Demand (PCU/hr)	Scaling Factor (%)
A		✓	278	100.000
B		✓	209	100.000
C		✓	329	100.000

Origin-Destination Data

Demand (PCU/hr)

	To			
	A	B	C	
From	A	0	16	262
	B	15	0	194
	C	187	142	0

Vehicle Mix

Heavy Vehicle Percentages

	To			
	A	B	C	
From	A	0	0	2
	B	0	0	0
	C	1	0	0

Results

Results Summary for whole modelled period

Stream	Max RFC	Max Delay (s)	Max Queue (PCU)	Max LOS
B-C	0.30	7.17	0.4	A
B-A	0.04	8.96	0.0	A
C-AB	0.31	7.31	0.6	A
C-A				
A-B				
A-C				

Main Results for each time segment

08:15 - 08:30

Stream	Total Demand (PCU/hr)	Capacity (PCU/hr)	RFC	Throughput (PCU/hr)	End queue (PCU)	Delay (s)	Unsignalised level of service
B-C	146	736	0.198	145	0.2	6.077	A
B-A	11	452	0.025	11	0.0	8.167	A
C-AB	135	685	0.197	133	0.3	6.537	A
C-A	113			113			
A-B	12			12			
A-C	197			197			

08:30 - 08:45

Stream	Total Demand (PCU/hr)	Capacity (PCU/hr)	RFC	Throughput (PCU/hr)	End queue (PCU)	Delay (s)	Unsignalised level of service
B-C	174	728	0.240	174	0.3	6.501	A
B-A	13	438	0.031	13	0.0	8.483	A
C-AB	169	697	0.242	168	0.4	6.823	A
C-A	127			127			
A-B	14			14			
A-C	236			236			

08:45 - 09:00

Stream	Total Demand (PCU/hr)	Capacity (PCU/hr)	RFC	Throughput (PCU/hr)	End queue (PCU)	Delay (s)	Unsignalised level of service
B-C	214	715	0.299	213	0.4	7.163	A
B-A	17	418	0.039	16	0.0	8.958	A
C-AB	220	715	0.308	219	0.6	7.287	A
C-A	142			142			
A-B	18			18			
A-C	288			288			

09:00 - 09:15

Stream	Total Demand (PCU/hr)	Capacity (PCU/hr)	RFC	Throughput (PCU/hr)	End queue (PCU)	Delay (s)	Unsignalised level of service
B-C	214	715	0.299	214	0.4	7.174	A
B-A	17	418	0.039	17	0.0	8.961	A
C-AB	220	715	0.308	220	0.6	7.308	A
C-A	142			142			
A-B	18			18			
A-C	288			288			

09:15 - 09:30

Stream	Total Demand (PCU/hr)	Capacity (PCU/hr)	RFC	Throughput (PCU/hr)	End queue (PCU)	Delay (s)	Unsignalised level of service
B-C	174	728	0.240	175	0.3	6.519	A
B-A	13	438	0.031	14	0.0	8.490	A
C-AB	169	698	0.242	169	0.4	6.854	A
C-A	127			127			
A-B	14			14			
A-C	236			236			

09:30 - 09:45

Stream	Total Demand (PCU/hr)	Capacity (PCU/hr)	RFC	Throughput (PCU/hr)	End queue (PCU)	Delay (s)	Unsignalised level of service
B-C	146	736	0.198	146	0.2	6.103	A
B-A	11	452	0.025	11	0.0	8.179	A
C-AB	135	685	0.197	135	0.3	6.578	A
C-A	113			113			
A-B	12			12			
A-C	197			197			

Appendix I RSA and Response drawings

Title: STAGE 1 ROAD SAFETY AUDIT
For;
Public Realm Redevelopment,
Market Square , Kildare, Co. Kildare

Client: AECOM

Date: October 2023

Report reference: 2047R01

VERSION: FINAL (5-12-2023)

Prepared By:

Bruton Consulting Engineers Ltd

**Glaspistol
Clogherhead
Drogheda
Co. Louth.**

**Tel: 041 9881456
Mob: 086 8067075
E: admin@brutonceng.ie
W: www.bruntonceng.ie**

CONTENTS SHEET

Contents

1.0	Introduction	2
2.0	Background	3
2.1	Brief Description of the Scheme	3
2.2	Collision History	4
3.0	Issues Raised in This Stage 1 Road Safety Audit.	5
3.1.	Problem.....	5
3.2	Problem.....	6
3.3	Problem.....	6
3.4	Problem.....	8
3.5	Problem.....	9
3.6	Problem.....	11
4.0	Observations.....	11
4.1	Observation.....	11
5.0	Audit Statement.....	12
	Appendix A – Information Provided	13
	Appendix B – Problem Location Map	14
	Appendix C – Feedback Form	15

1.0 Introduction

This report was prepared in response to a request from Ms. Hilary Herlihy, AECOM, for a Stage 1 Road Safety Audit of the proposed public realm upgrade at Market Square, Kildare, Co. Kildare.

The Road Safety Audit Team comprised of;

Team Leader: **Norman Bruton**, BE CEng FIEI, Cert Comp RSA.

TII Road safety Auditor approval number: NB 168446

Team Member: **Owen O'Reilly**, B.SC. Eng Dip Struct. Eng NCEA Civil Dip Civil. Eng CEng MIEI

TII Auditor Approval no. OO 1291756

The Road Safety Audit comprised an examination of the drawings provided and a site visit by the Audit Team on the 25th of October 2023. The weather at the time of the site visit was dry and the road surface was also dry.

This Stage 1 Road Safety Audit has been carried out in accordance with the requirements of TII Publication Number GE-STY-01024, dated December 2017.

The scheme has been examined and this report compiled in respect of the consideration of those matters that have an adverse effect on road safety. It has not been examined or verified for compliance with any other standards or criteria.

The problems identified in this report are considered to require action in order to improve the safety of the scheme for road users.

If any of the recommendations within this safety audit report are not accepted, a written response is required, stating reasons for non-acceptance. Comments made within the report under the heading of Observation are intended to be for information only. Written responses to Observations are not required.

A list of the documents provided to the Audit Team is provided in **Appendix A**.

A problem Location map is provided in **Appendix B**

The Feedback form is provided in **Appendix C**

2.0 Background

2.1 Brief Description of the Scheme

The purpose of this scheme is to secure long-lasting transport improvements in Kildare Town to ensure growing use of sustainable travel modes for work, education, business and visitor trips. The scheme aims to pedestrianise areas of Market Square in Kildare town centre to reduce car dependency and encourage more sustainable modes of travel. This includes the closure of the Bride Street section of Market Square in the medium to long term once the Magee Barracks roads are in place.

The design consists of temporary closures of Bride Street and the Market Square roads on market days with the use of a retractable bollard system preventing the traffic from entering the restricted streets on market day.

Kildare Town Market Square is situated at the centre of Kildare in County Kildare, Ireland. The site contains a junction intersecting the R415 and the R445. Both R- roads connect to the M7 motorway, R415 connects to the M7 to the South of Kildare and the R445 joins the M7 to the East of Kildare.

The Kildare Town Market Square scheme has been designed in accordance with the Design Manual for Urban Roads and Streets (DMURS).

The Design Speed for each route in the scheme is as follows:

Route	Design Speed (kph)
R445 Dublin Street	50
R445 Claregate Street	50
R415 Bride Street*	50
Market Square	50

The site location is shown below.

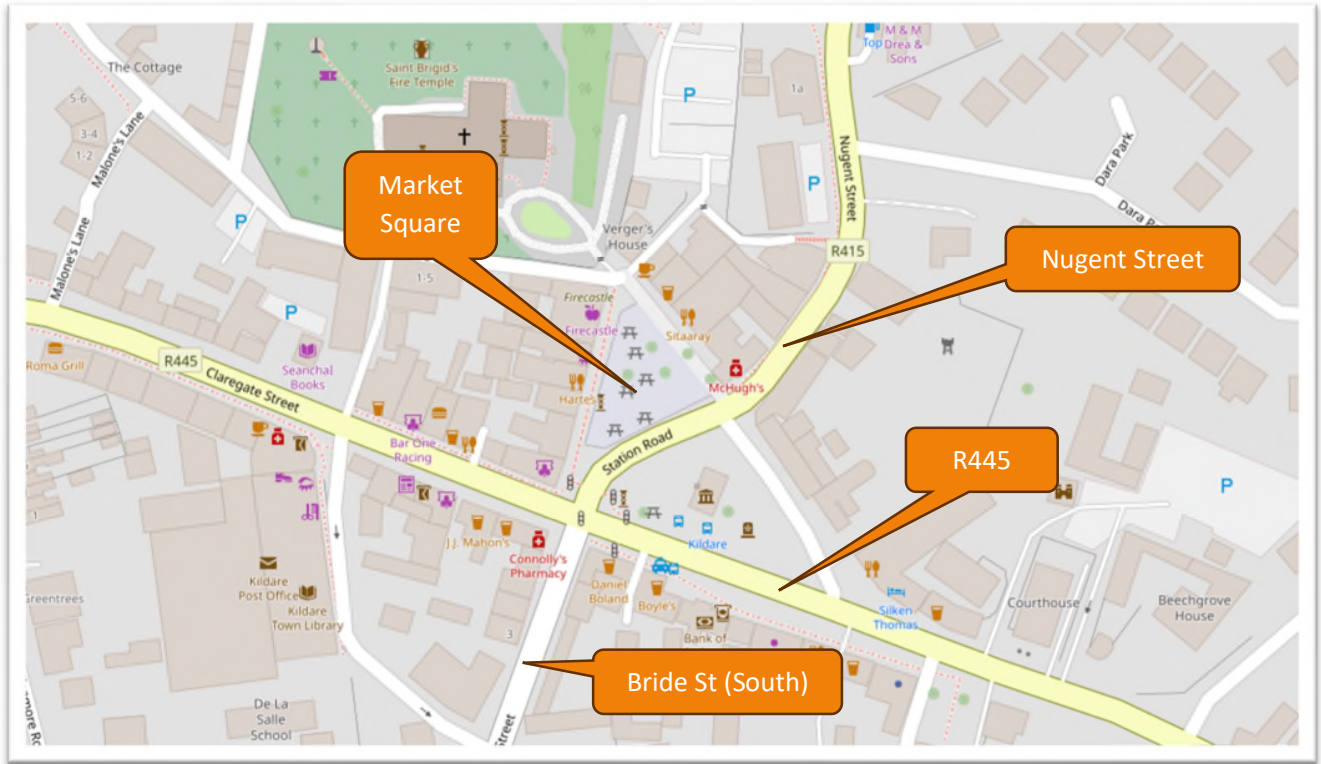

Image courtesy of openstreetmap.org

2.2 Collision History

The Road Safety Authority's website www.rsa.ie did not provide historic collision data at the time of writing this report due to ongoing issues with data sharing.

3.0 Issues Raised in This Stage 1 Road Safety Audit.

3.1. Problem

LOCATION

Drawing 60594179-ACM-00-XX-SK-CE-10-0006 Rev C, Rising bollards.

PROBLEM

It is proposed to provide rising bollards to prevent access on market days. Drivers unfamiliar with the area may not see the bollards until they have turned off the R445 which could lead to reversing manoeuvres and possible rear-end collisions.



RECOMMENDATION.

It is recommended that suitable signage is provided to warn drivers of the restricted traffic movements during market days. The signalised junction at Bride Street (South) should not give conflicting signal information with allowable movements during market days.

STAGE 1 RSA – MARKET SQUARE KILDARE AECOM

3.2 Problem

LOCATION

Drawing 60594179-ACM-00-XX-SK-CE-10-0006 Rev C, Rising bollards, Nugent Street.

PROBLEM

If a driver travels towards Market Square from Nugent Street and the bollards are risen they may not have room to turn and travel back. This could lead to collisions with vulnerable road users, street furniture or buildings.



RECOMMENDATION.

It is recommended that a warning system for road closure on Market days be provided at the previous junction(s) to ensure drivers do not travel on Nugent Street to Market Square.

3.3 Problem

LOCATION

Drawing 60594179-ACM-00-XX-SK-CE-10-0002 Rev A, Swept path analysis, R445/Bride Street Junction.

PROBLEM

The swept path analysis for the refuse vehicles shows overlap close to the stop line of the proposed signalised junction. If one wide vehicle is stopped at the signals another will not be able to undertake the turn. This could lead to side-swipe collisions. Many large vehicles were observed at this location during the site visit.





RECOMMENDATION.

Ensure sufficient space is provided at the signalised junction for turning vehicles assuming that other vehicles are waiting at the stop line. Vehicles larger than refuse vehicles may be undertaking these manoeuvres, the articulated vehicle swept path analysis only shows a single movement. Stop lines may need to be set back on a weight restriction be provided and alternative routes for larger vehicles.

3.4 Problem

LOCATION

Drawing 60594179-ACM-00-XX-SK-CE-10-0006 Rev C, Shared Surface.

PROBLEM

The shared use surface terminates on approach to the signalised junction on Bride Street (North). Blind or partially sighted pedestrians may not know that they are leaving a shared use area which could lead to collisions with vehicles whose drivers don't expect such movements.

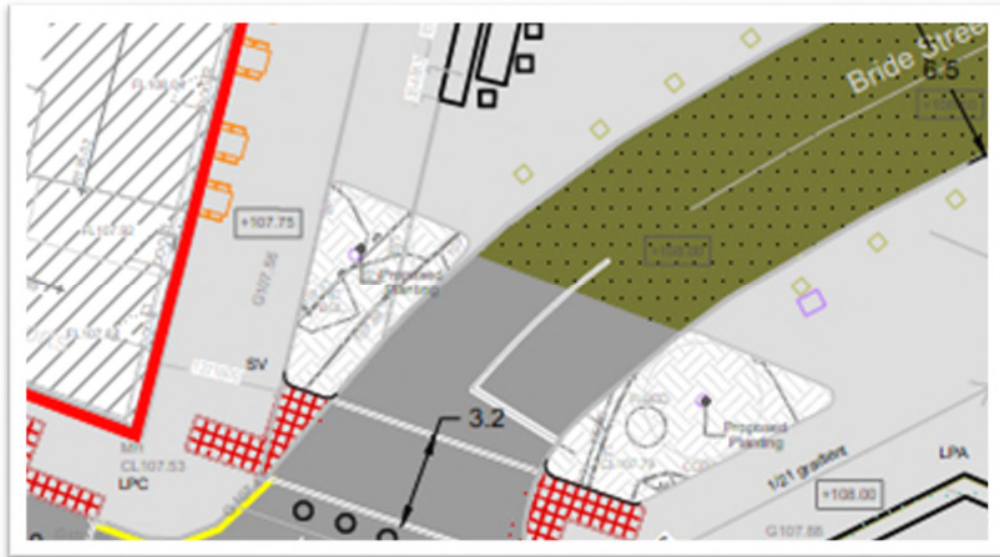

RECOMMENDATION.

It is recommended that suitable tactile paving or other features be provided to denote the end of the shared use surfacing at all locations where it terminates.

3.5 Problem

LOCATION

Drawing 60594179-ACM-00-XX-SK-CE-10-0006 Rev C, & 60594179-ACM-00-XX-SK-CE-10-0002 Rev A, Swept path analysis Parking spaces on Market Square.

PROBLEM

There are three parking spaces on Market Square. The two standard sized spaces are located off a proposed 4.8m shared use street. This may lead to difficulty for drivers to get into and out of the spaces if the adjacent spaces are occupied. It was noted that these spaces are currently reserved as age friendly and for those with hidden disabilities and if retained for such use the drivers may be somewhat mobility impaired. Although the swept path analysis is provided it is unclear how easily these movements can be undertaken.



RECOMMENDATION.

It is recommended that suitably sized parking spaces be provided for their intended use.

STAGE 1 RSA – MARKET SQUARE KILDARE AECOM

3.6 Problem

LOCATION

Sire Observation. ESB pole at proposed crossing.

PROBLEM

There is a large ESB pole close to the proposed pedestrian crossing on the western side of the Bride Road Junction with the R445. This could reduce the effective width of the footpath for pedestrians, especially the mobility impaired leading to some stepping onto the carriageway where they would be at greater risk of being struck by passing/turning vehicles.



RECOMMENDATION.

It is recommended that the pole be relocated or the services provided underground.

4.0 Observations

4.1 Observation

It is assumed that persons with responsibility with lowering the bollards will be on site during market days to allow local access and emergency vehicles through.

5.0 Audit Statement

We certify that we have examined of the documents provided and the site. The examination has been carried out with the sole purpose of identifying any aspects of the designs which could be added, removed or modified in order to improve the safety of the scheme.

The audit has been carried out by the persons named below who have not been involved in any design work on this scheme as a member of the Design Team.

Norman Bruton Signed: 
(Audit Team Leader) Dated: 5/12/2023

Owen O'Reilly Signed: 
(Audit Team Member) Dated: 5/12/2023

Appendix A – Information Provided

Information Supplied to the Audit Team

Drawing -ACM-XX-XX-SK-CE-10-0105_P03

Drawing -ACM-XX-XX-SK-CE-10-1201_P05

Drawing -ACM-XX-XX-SK-CE-10-0101_P03

Drawing -ACM-XX-XX-SK-CE-10-0102_P03

Drawing -ACM-XX-XX-SK-CE-10-0103_P03

Drawing -ACM-XX-XX-SK-CE-10-0104_P03

Background Information Provided

Audit Brief

Traffic flow data

Appendix B – Problem Location Map

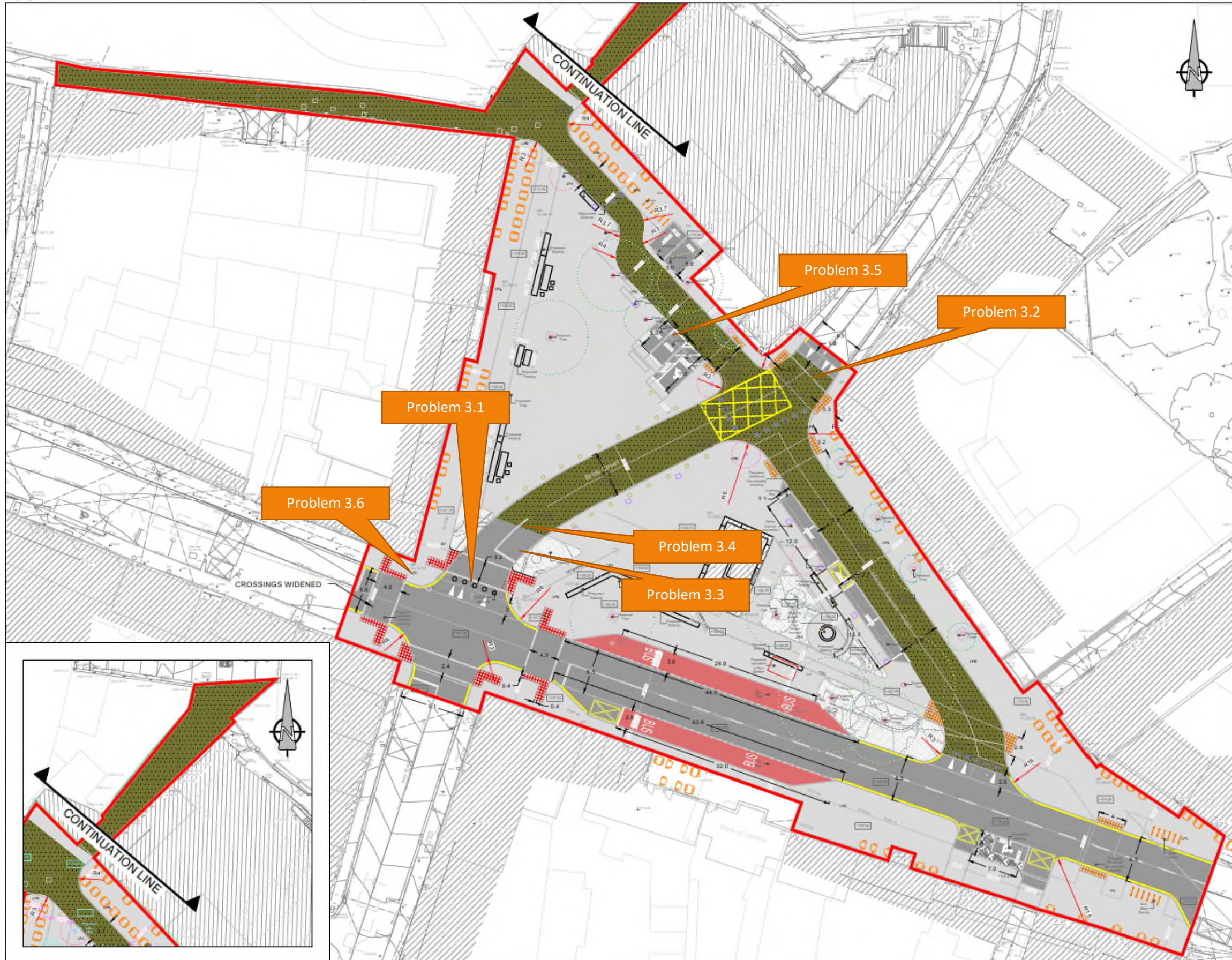

PROJECT
KILDARE MARKET SQUARE,
CO.KILDARE

CLIENT
KILDARE COUNTY COUNCIL

CONSULTANT
AECOM
4th Floor Adelphi Plaza,
George's Street Upper,
Dun Laoghaire,
Co Dublin
Tel:+353 (0)1 6966220
www.aecom.com

- NOTES**
- THIS DRAWING IS TO BE READ IN CONJUNCTION WITH ALL OTHER RELEVANT ARCHITECTURAL AND ENGINEERING DRAWINGS. ANY DISCREPANCIES, ERRORS OR OMISSIONS TO BE BROUGHT TO THE ATTENTION OF THE DESIGNER.
 - ALL DIMENSIONS TO BE CHECKED BY THE CONTRACTOR ON SITE PRIOR TO COMMENCEMENT OF WORKS.
 - AECOM LIMITED TO BE INFORMED BY THE CONTRACTOR OF ANY DISCREPANCIES PRIOR TO THE COMMENCEMENT OF WORKS ON SITE.
 - DIMENSIONS OF ALL BOUNDARIES AND ADJOINING ROADS TO BE CHECKED ON SITE PRIOR TO COMMENCEMENT OF WORKS.

LEGEND

	RED LINE BOUNDARY
	CONTROLLED TACTILE PAVING
	UNCONTROLLED TACTILE PAVING
	ROAD HATCH
	FOOTPATH/PEDESTRIAN HATCH
	BUS STOP HATCH
	SHARED SURFACE HATCH
	ROAD MARKINGS
	RETRACTABLE BOLLARDS
	INDICATIVE CYCLE PARKING

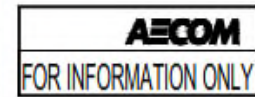

ISSUE/REVISION

IR	DATE	DESCRIPTION
C	17.07.2023	RESPONSE TO METWORKS
B	08.07.2023	ISSUED FOR INFORMATION
A	15.06.2023	ISSUED FOR INFORMATION

PROJECT NUMBER
60594179

SHEET TITLE
ROAD MARKINGS & DIMENSIONS

SHEET NUMBER
60594179-ACM-00-XX-SK-CE-10-0006



A ROAD MARKINGS & DIMENSIONS
0006 Scale: 1:250

Appendix C – Feedback Form

STAGE 1 RSA – MARKET SQUARE KILDARE
AECOM



Scheme: Market Square, Kildare

Stage: 1 Road Safety Audit

Date Audit (Site Visit) Completed:15-10-2023

Paragraph No. in Safety Audit Report	Problem accepted (yes/no)	Recommended measure accepted (yes/no)	Alternative measures (describe)	Alternative measures accepted by Auditors (Yes/No)
3.1	Y	Y	Measure accepted Drawings 60594179-ACM-00-XX-SK-CE-10-1007, 60594179-ACM-00-XX-SK-CE-10-1008 and 60594179-ACM-00-XX-SK-CE-10-1009 have been provide. showing potential locations for temporary signage to inform road uses about road closures and forbidden turns that can be erected during market days.	Yes
3.2	Y	Y	Measure accepted Drawings 60594179-ACM-00-XX-SK-CE-10-1007, 60594179-ACM-00-XX-SK-CE-10-1008 and 60594179-ACM-00-XX-SK-CE-10-1009 have been provide. showing potential locations for temporary signage to inform road uses about road closures and forbidden turns that can be erected during market days.	Yes
3.3	Y	Y	Swept paths at the R445/Bride Street Junction have been revised to check there is sufficient space at the signalised junction for turning vehicles assuming that other vehicles are waiting at the stop line. Swept path has also been separated based on the two phases of the signalised junction to give a clearer view of which vehicles movements will be taking part simultaneously. This can be seen in updated drawing 60594179-ACM-00-XX-SK-CE-10-0002 in Appendix A.	Yes
3.4	Y	Partially Y	Bollards (and planters) will be provided along the footway edge to	

			demarcate the difference between the carriageway and the footway. On market days removable bollards are being provided across the carriageway which will prevent vehicular traffic and also warn pedestrians of the end of the shared area. Tactile will be extended to building line and guidance path surface to be provided along the edge of the ped route, south to the planters and to meet the red tactile paving generally to a depth of 800mm. For clarity it will not be provided across the carriageway to prevent any pedestrians mistaken it on non-market days.	Yes
3.5	Y	N	Swept paths for cars using the provided parking spaces have been shown more clearly in the updated 60594179-ACM-00-XX-SK-CE-10-0001 drawing which can be found in Appendix A. The size of the parking spaces are as existing so will not be amended.	Yes
3.6	Y	Y	Pole to be removed	Yes

Signed *Aoife O'Donnell*
Design Team Leader

Date.....04.12.23.....

Signed *Ashmen Bruton*
Audit Team Leader

Date....5/12/2023....

Signed *Jennifer Seale*
Employer/Developer

Date...04.12.23.....

aecom.com